

UNI-SHOP GUIDE

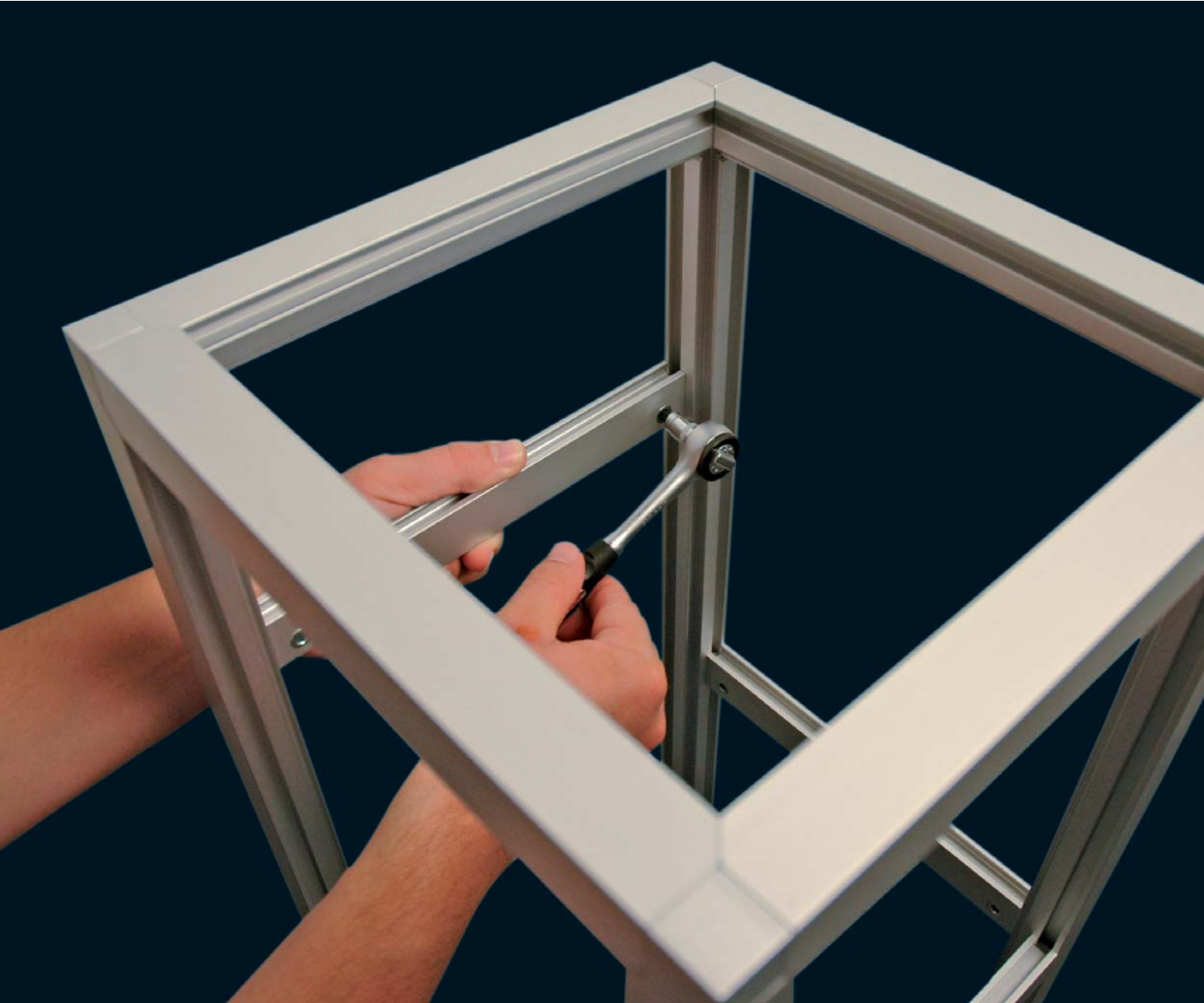

WORKING WITH
UNI-SHOP AND SELECT

SYSTEM
STANDEX®

Standex UniShop comprises the following components

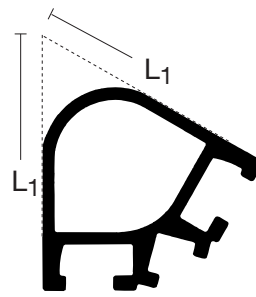

NOTE!
The starting point for all dimension calculations is the outer measurements (L_1 og H_1) of the counter or vitrine.
With oblique angles, the dimensions are calculated according to the theoretical corners - where the extensions of the sides intersect, e.g.:

Rounded corner profiles

Accessories

90° corner

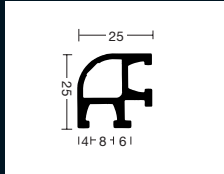

RC 44 - 2 R

90° end cap



US 6

90° end cap for adjustable foot



US 6 G M8

Connector plug for glued assemblies



PH 44 - 3R

Screw fitting for PH44-3R assembly without adhesive



US 20

135° corner

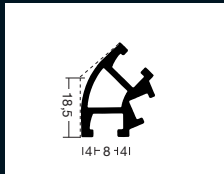

RC 44 - 3 R

135° end cap



US 3

135° end cap for adjustable foot



US 3 G M8

Adjustable foot

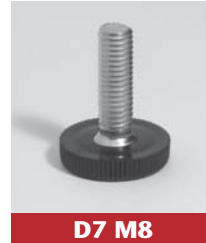

D7 M8

Adjustable foot



D9 M8

60° corner

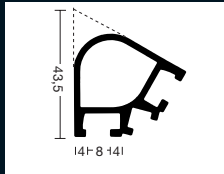

RC 44 - 4 R

60° end cap



US 10

60° end cap for adjustable foot



US 10 G M8

Fitting for connection of two corner profiles



US 21

120° corner

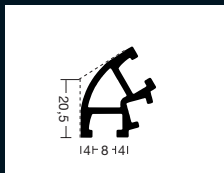

RC 44 - 6 R

120° end cap



US 11

120° end cap for adjustable foot



US 11 G M8

Corner profile

90° Corner

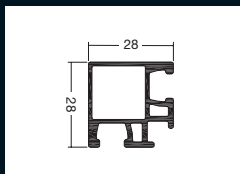

RC 44 - 2

Assembly sections for RC 44-2 profiles, 20 mm



Type P and SE

RC 44-2 combines Standex Unishop and Standex constructional systems. See special brochure.

Rounded profiles for top and bottom

Large profile for 10 mm plate

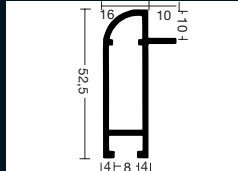

RC 44 - 5 R10

Large profile for 20 mm plate

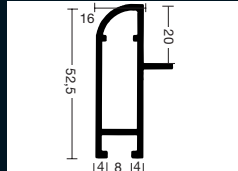

RC 44 - 5 R20

Intermediate profiles

Vertical or horizontal intermediate profile

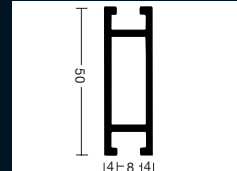

RC 44 - 5

Small profile for 10 mm plate

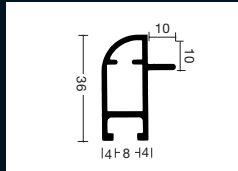

RC 36 - 5 R10

Small profile

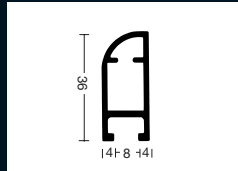

RC 36 - 1R

Vertical or horizontal intermediate profile

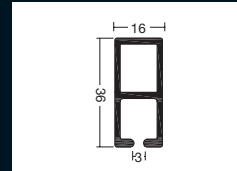

RC 36 - 8

Vertical or horizontal intermediate profile

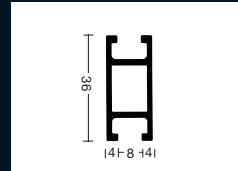

RC 36 - 5

Vertical intermediate profile for p

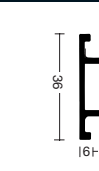

RC 36 - 5

Calculating the length of the profiles

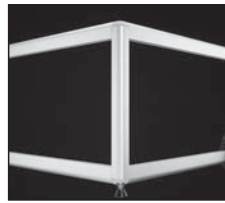

Calculating the size of the panels



Length and width

Height

Top panel

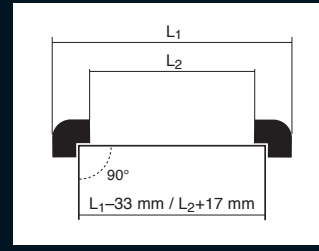
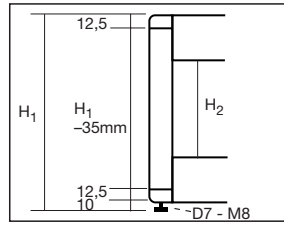
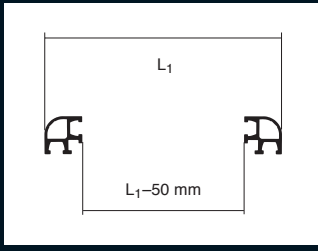

Fitting side panel

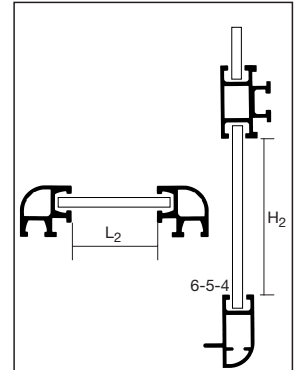

Panel sizes:
 6 mm: $L_2 + 14\text{ mm} \times H_2 + 14\text{ mm}$
 (inserted without gasket)
 5 mm: $L_2 + 12\text{ mm} \times H_2 + 12\text{ mm}$
 (inserted with gasket PL1)
 4 mm: $L_2 + 9\text{ mm} \times H_2 + 9\text{ mm}$
 (inserted with gasket GU1)

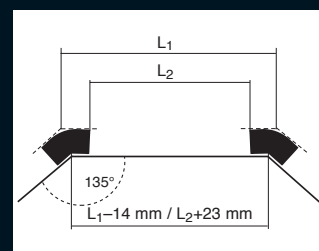
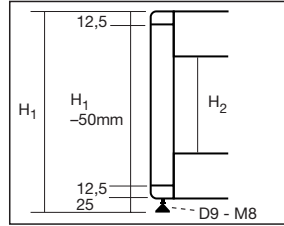
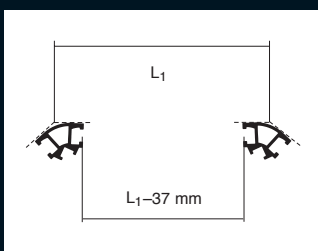

Position of holes for connector screw

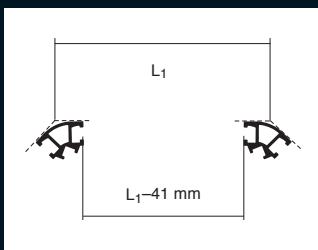
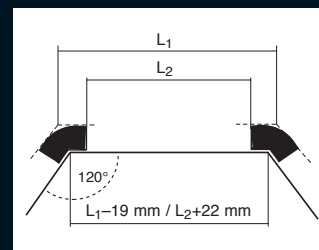
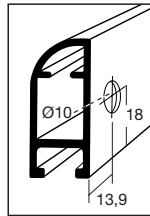
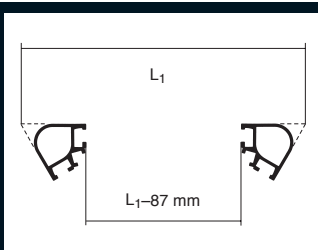
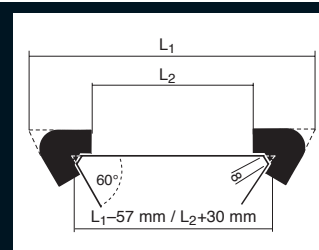
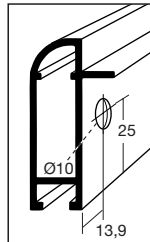

Fitting top glass

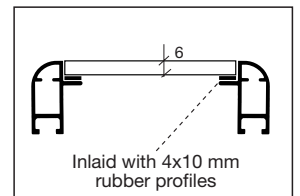

Connectors

Connector for RC 44 profiles



PC 44 - 5

Connector for glued assemblies without corner profiles



I 44 - A

Connector for glued assemblies without corner profiles



I 44 - 5 90°

Connector for glued assemblies without corner profiles



I 44 - 5 120°

Connector for glued assemblies without corner profiles



I 44 - 5 135°

Supplementary profiles

Profile for connection to other materials



C 16 - 10

Cover profile

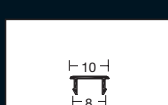

RC 40 - D

Profile for supporting shelves or lighting units

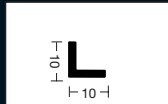

L 10 - 2

Intermediate partition wall

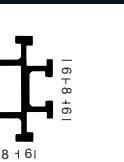

36 - 3

Vertical or horizontal intermediate profile

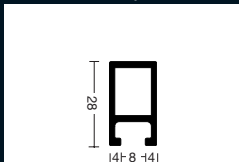

RC 36 - 1

Connector for RC 36 profiles



PC 36 - 5

Guide for RC 36 profiles

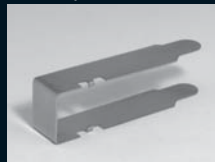

36 M

Connector for glued assemblies without corner profiles



I 36 - A

Screw for connector



Cover plug for connector screw



US 22

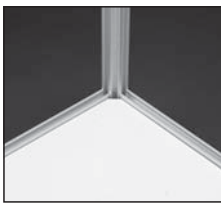

Bottoms and intermediate panels



Shelves

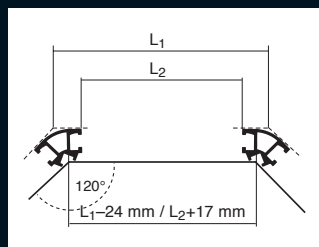
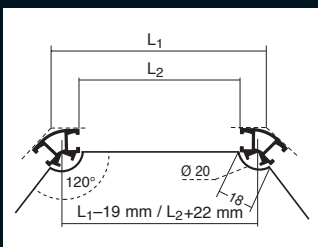
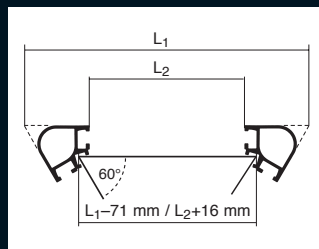
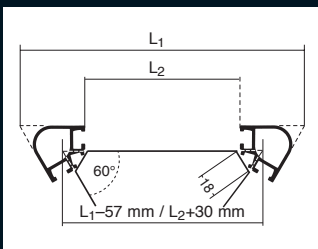
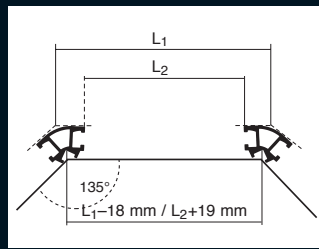
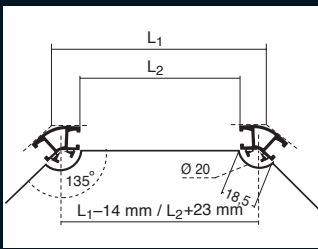
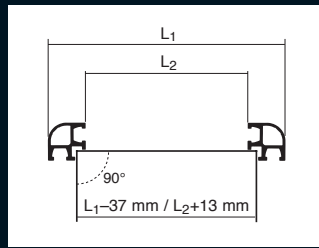
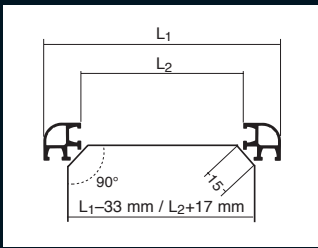

Connection with PH 44 - 3R

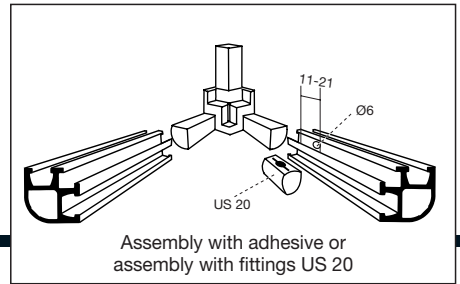

Sliding doors

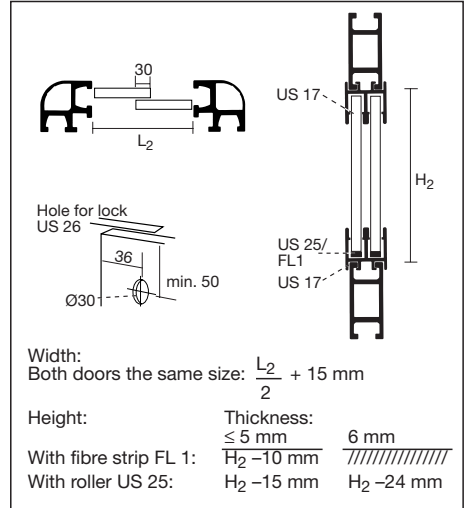

Hinged doors

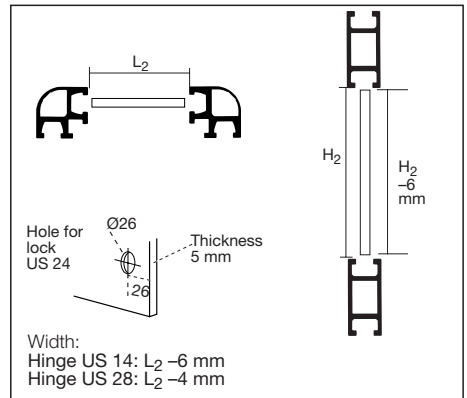

Fitting the panels

Shelf supports

Sliding doors

Hinged doors

Glass gasket for 5 mm (and 6 mm) glass

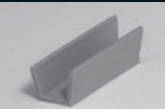

PL 1

Shelf support for wooden shelves (for corner profiles)



US 18

Shelf support for glass shelves (for corner profiles)



US 18 G

Profile for sliding doors

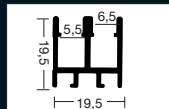

US 17

Lock for sliding doors



US 26

Glass gasket for 4 mm (and 5 mm) glass



GU 1

Shelf support for wooden shelves (for T-groove)



US 19

Fibre strip for sliding doors



FL 1

Roller for sliding doors



US 25

Hinges for glass door (set)



US 14

Lock for hinged glass door



US 24

Hinges with pin for glass door (set)



US 28

Panel holder



US 23

Shelf support for T-groove. 150, 200, 250 and 300 mm

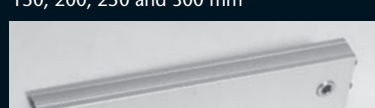

US 27...mm

Stop for glass door (90°, 60°, 120°, 135°)



US 15...°

Stop for double door



US 29

STANDEX SELECT NOTICEBOARD

A well-thought-through constructional system for the manufacture of noticeboards.
Select noticeboards with a depth of either 100 mm or 52 mm.

Frame profile

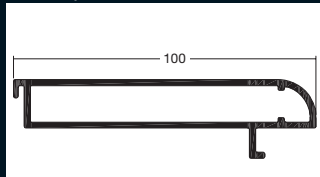

RC100-R20

Frame profile

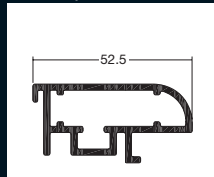

RC52-R20

Door profile

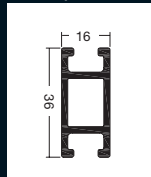

RC36-5

Door profile

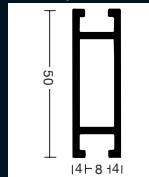

RC 44-5

Hinge

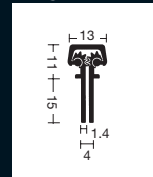

500-816-17

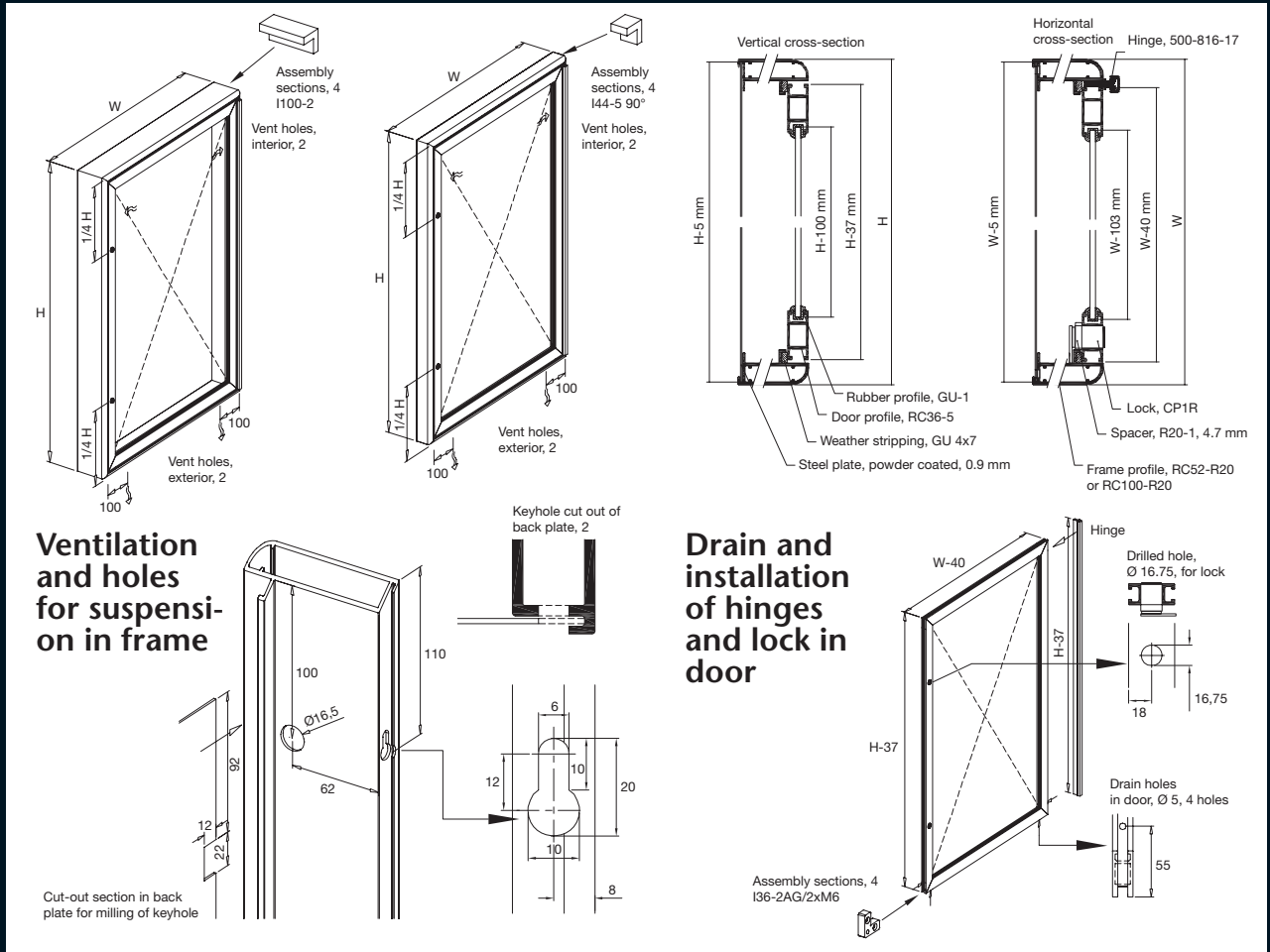

Assembly sections for case

Glued joints 52,5 mm



I 44 - 5 90°

Assembly sections for door

Glued joints 50 mm



I 44 - 2A

Joints with screws 50 mm



I 44 - 2AG/2xM6

Weather-proofing

Rubber profile, self-adhesive



GU4x7

Lock

Lock



CP1R

Glued joints 100 mm



I 100 - 2

Glued joints 36 mm



I 36 - 2A

Joints with screws 36 mm



I 36 - 2AG/2xM6

Inserted glass



GU-1

Spacer (lock included)



R20-1 4.7 mm

DESIGN USING SYSTEM STANDEX

Standex UniShop is a flexible system which can be used to design shopfittings in almost any form imaginable. It offers you the potential to resolve solutions which are adapted to the needs of your customers. As a result, Standex UniShop gives you an excellent foundation for satisfying your customers and running a successful business.

When it comes to presentation, the sky's the limit. In the majority of cases, it is simple to work out how the constructions should be designed. Available is a profile and component specification sheet that you can work with, as well as giving instructions on how to shorten the profiles so that the dimensions of the finished fittings match your requirements.

In principle, a solution almost always consists of vertical corner profiles, horizontal profiles for top and bottom, as well as any intermediate profiles required.

In the drawings, we show how to calculate dimensions for cutting profiles in relation to the finished external dimensions. We then show how to calculate the sizes of the top and side plates, as well as of shelves and partitions. Finally, we give instructions on various types of door.

If you are in any doubt about the details, please feel free to contact System Standex.



System Standex A/S
Herluf Trolles Vej 140
DK-5220 Odense SØ
Tel. +45 66 15 66 15
Fax +45 66 15 55 48
info@system-standex.dk

www.system-standex.dk