

# How to work with Fabric Frames

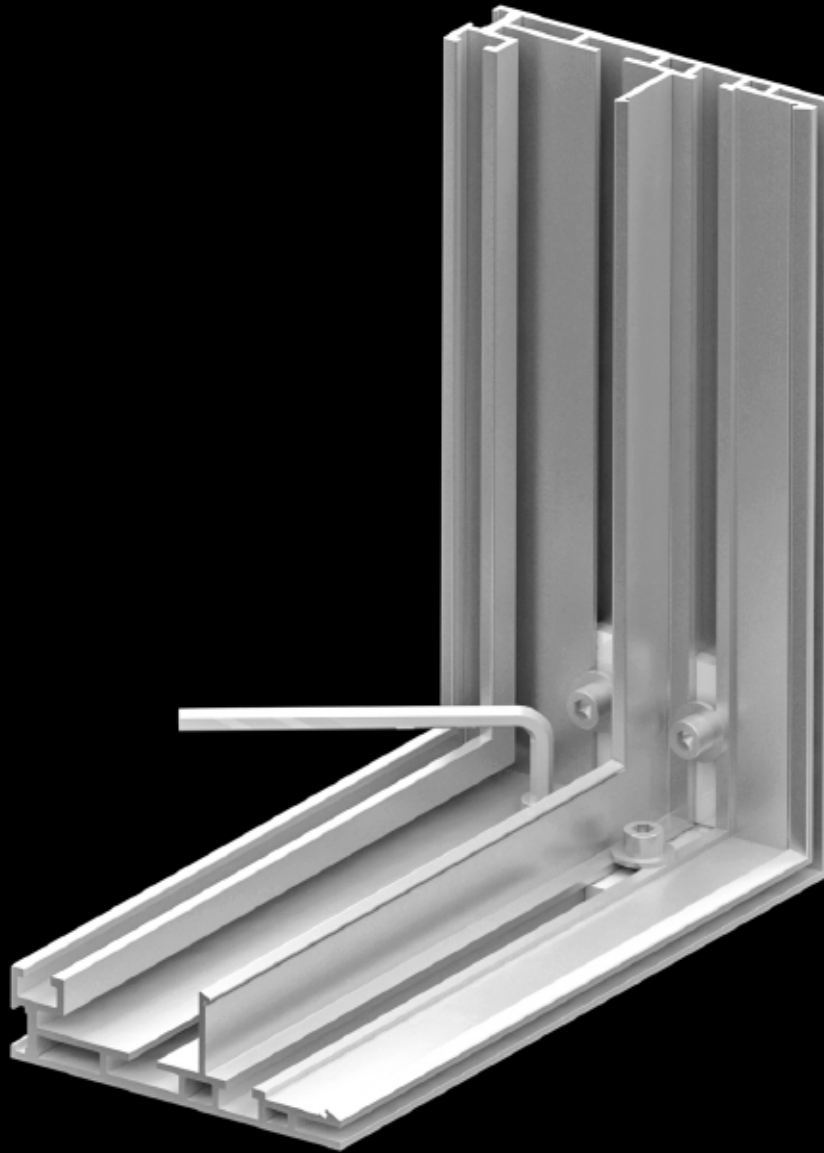

- Assembly instructions
- Frame construction
- Accessories
- Fabric information
- SF-Door & EL-Doors

**SYSTEM**  
**STANDEX®**

# How to work with Fabric Frames

## Table of contents:

Assembly of SF-44-1, SF-44-2, SF-44-2-C, SF-44-4, SF-44-6, SF-44-9, SF-44-85, SF-44-120 frames.....	3
Assembly of SF-44-5 frames.....	4
Assembly of SF-44-7, SF-44-8 frames.....	5
Assembly of SF-44-10 frames.....	6
Assembly of SF-36-2 frames.....	7
Assembly of SF-44-2A frames.....	8
Assembly of SF-44-100, SF-44-150-2 frames.....	9
Assembly of SF-44-120-2, SF-44-150 frames.....	10
Assembly of BLF frames.....	11
Assembly of modular frames.....	12
Assembly of SF-44-44-2 frames.....	13
Assembly of SF-44-44-4 frames.....	14
Frame construction.....	15-17
Assembly of SF-44-door.....	18
Assembly of EL-DOOR-1 and EL-DOOR -2.....	19
Assembly of EL-DOOR-3.....	20
TV bracket.....	21
Assembly of SF-44-H.....	22
Wall brackets.....	23
Steel bases.....	24-26
Fabric.....	27
For more information.....	28

# How to work with Fabric Frames

Valid for profiles:

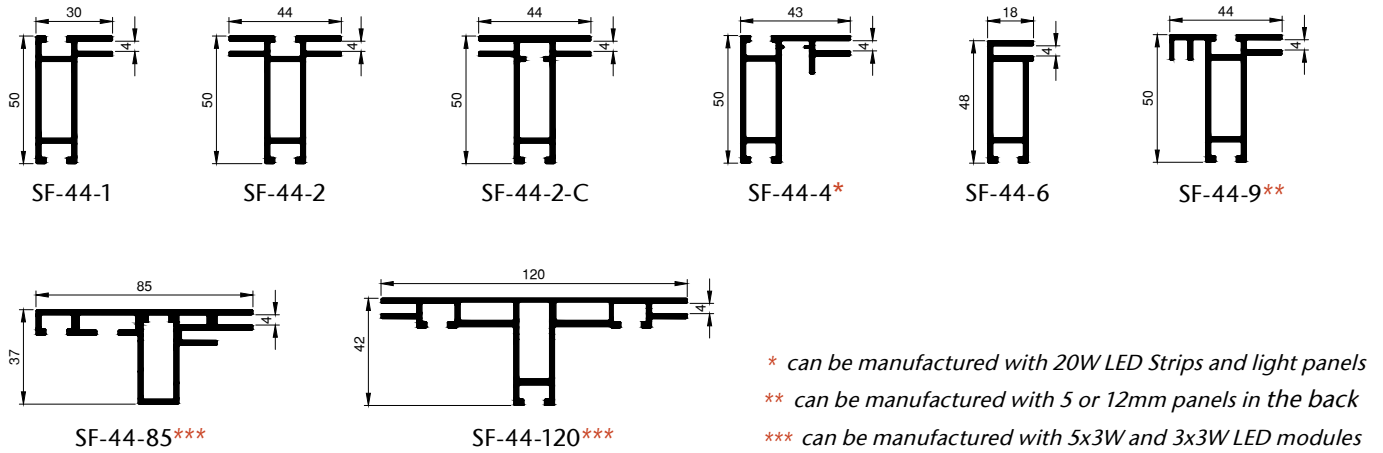

Assembly instructions:

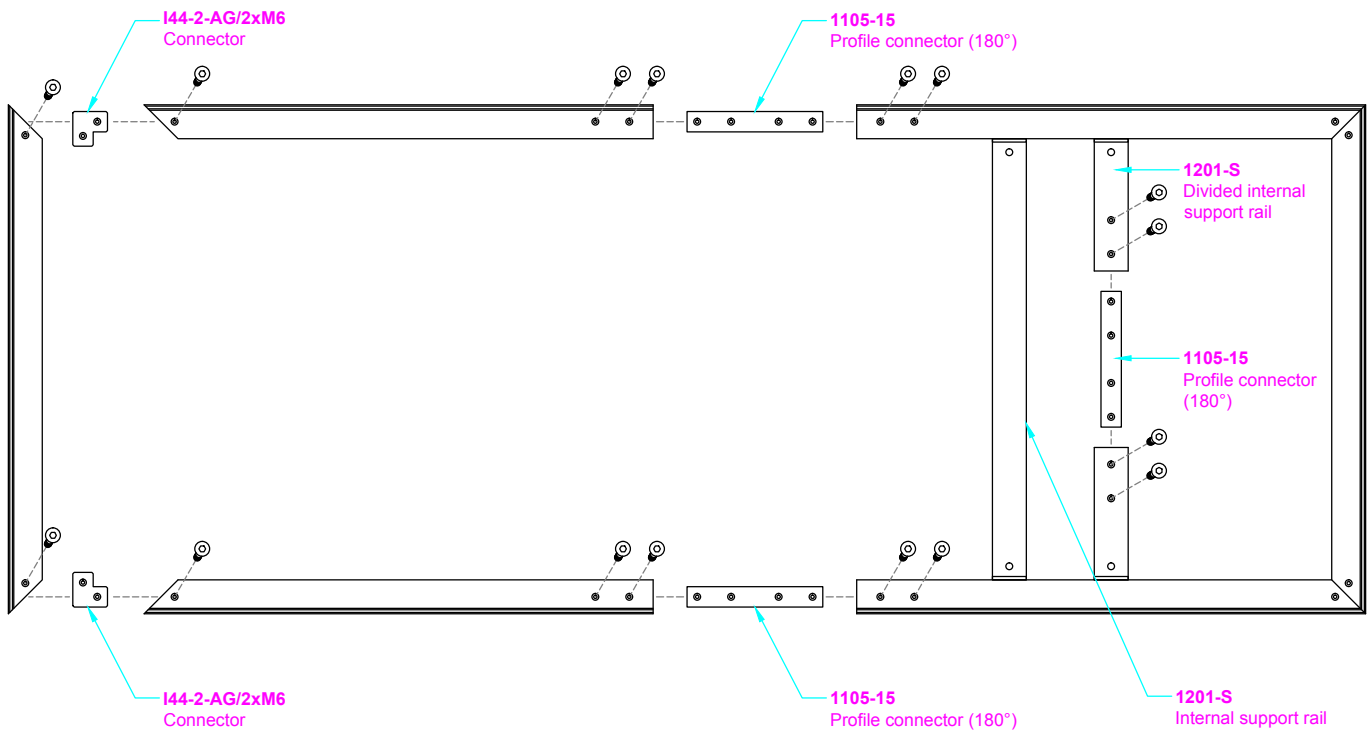

Accessories:

Connector	Handle	Profile connector (180°)	Internal support rail
I44-2-AG/2xM6	SF-HANDLE#	1105-15	1201-S

# cannot be used for SF-44-2-C, SF-44-6, SF-44-85 and SF-44-120

# How to work with Fabric Frames

Valid for profiles:

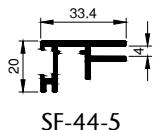

## Assembly instructions:

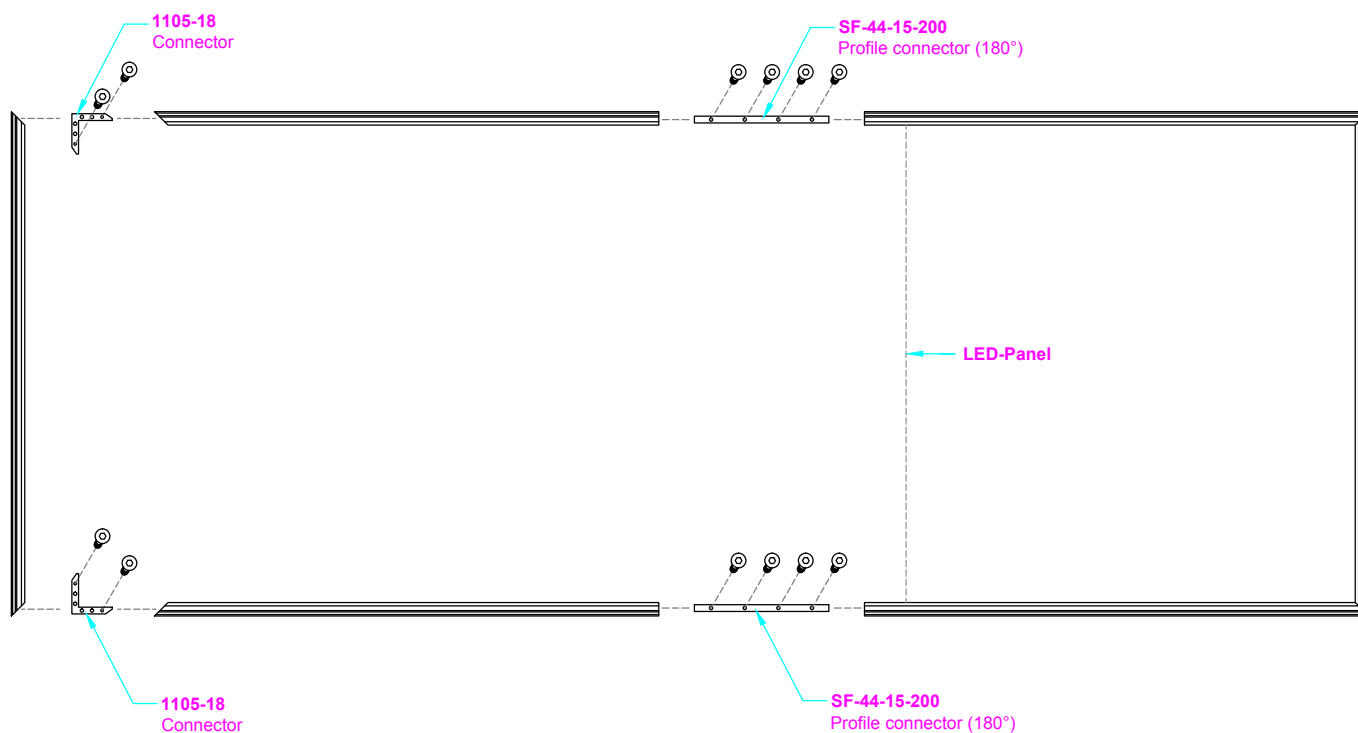

## Accessories:

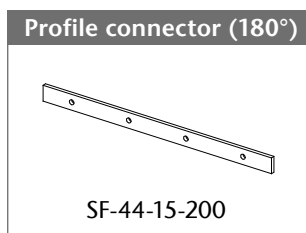
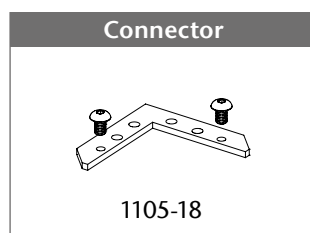

# How to work with Fabric Frames

Valid for profiles:

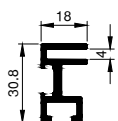

SF-44-7

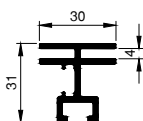

SF-44-8

## Assembly instructions:

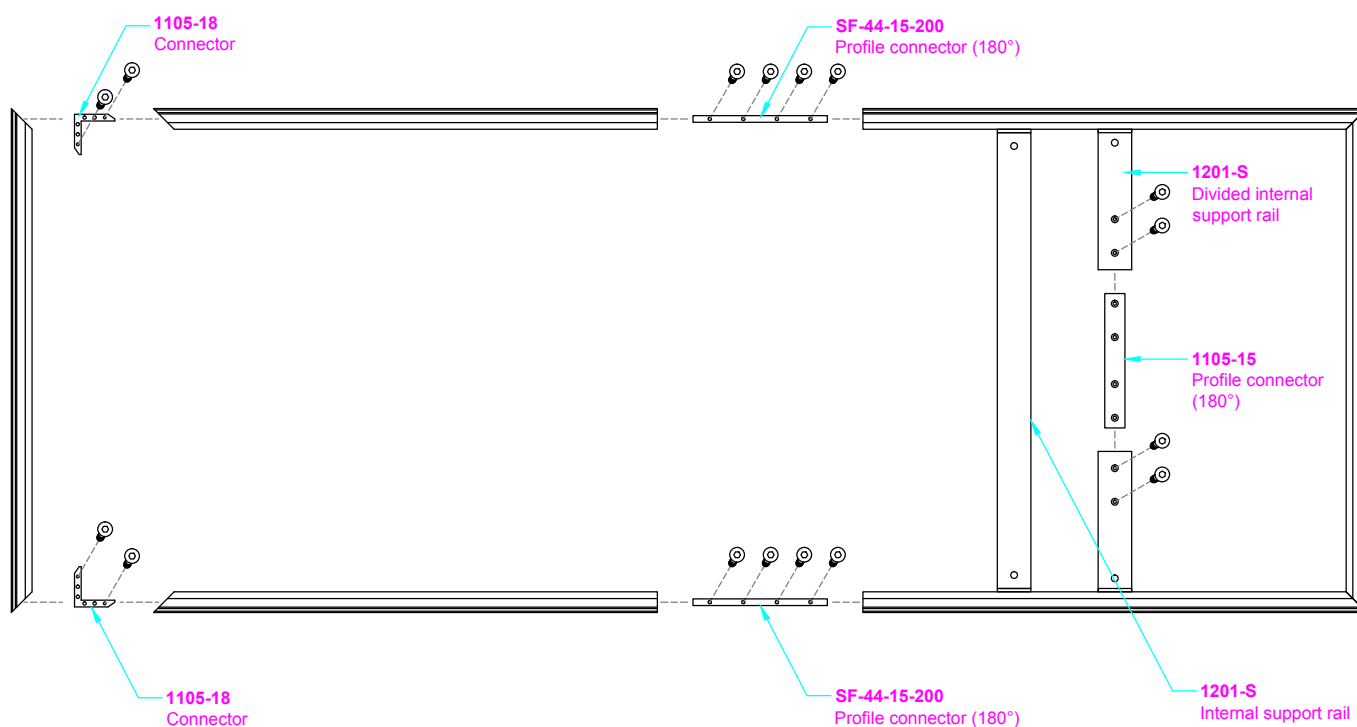

## Accessories:

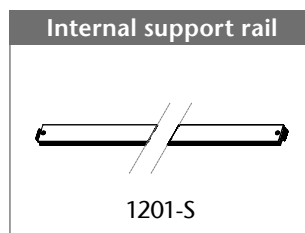
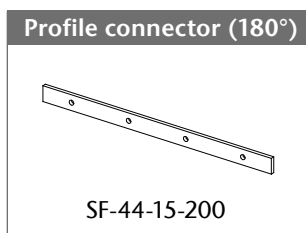
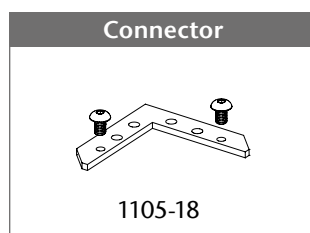

# How to work with Fabric Frames

Valid for profiles:

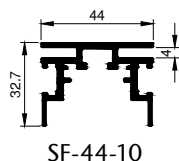

## Assembly instructions:

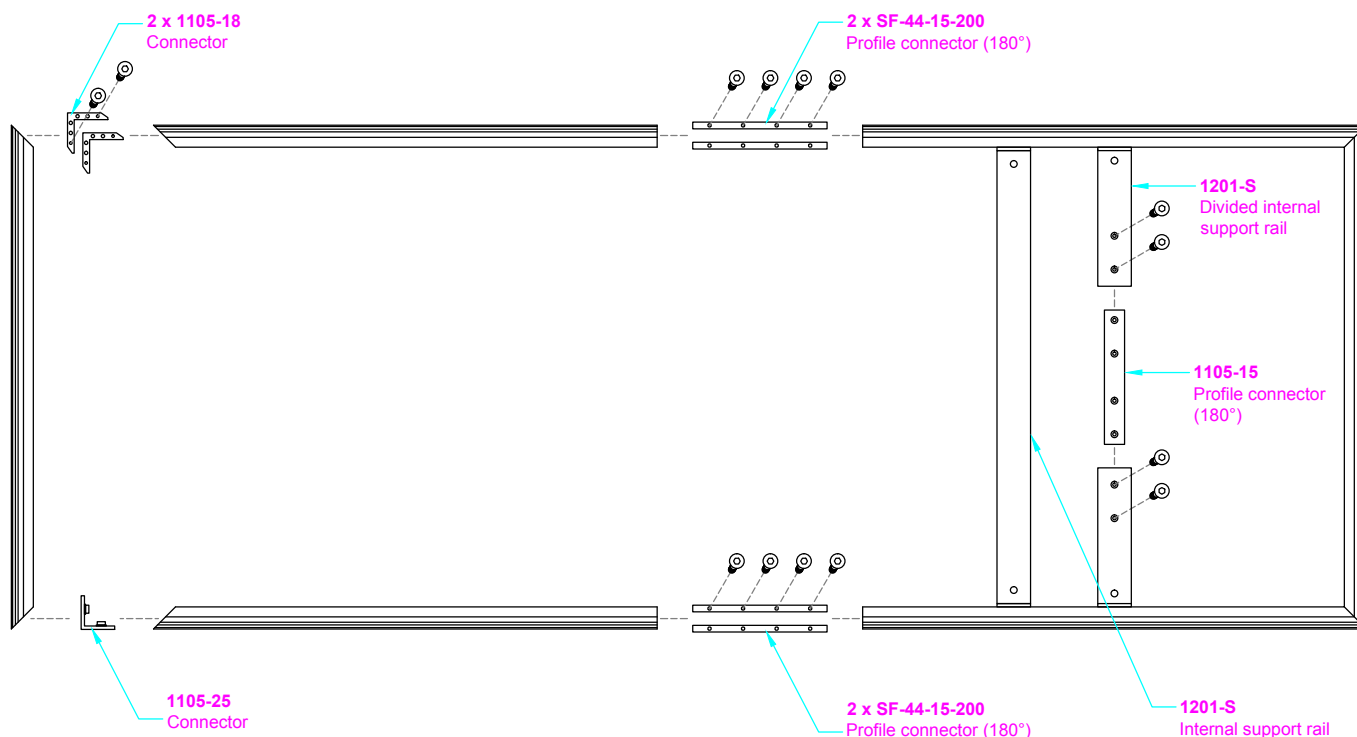

## Accessories:

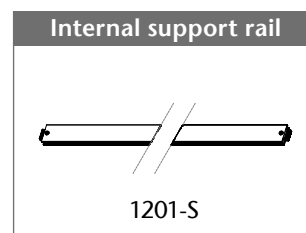
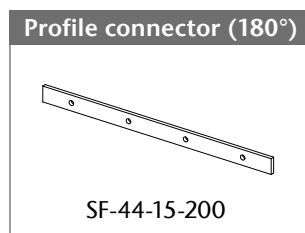
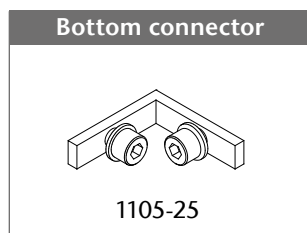
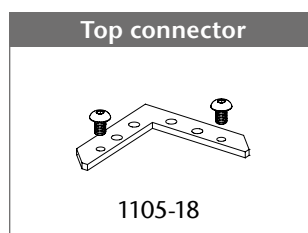

w/ special screws: PC44-5-SF10

# How to work with Fabric Frames

Valid for profiles:

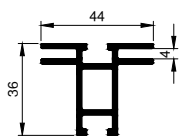

SF-36-2

## Assembly instructions:

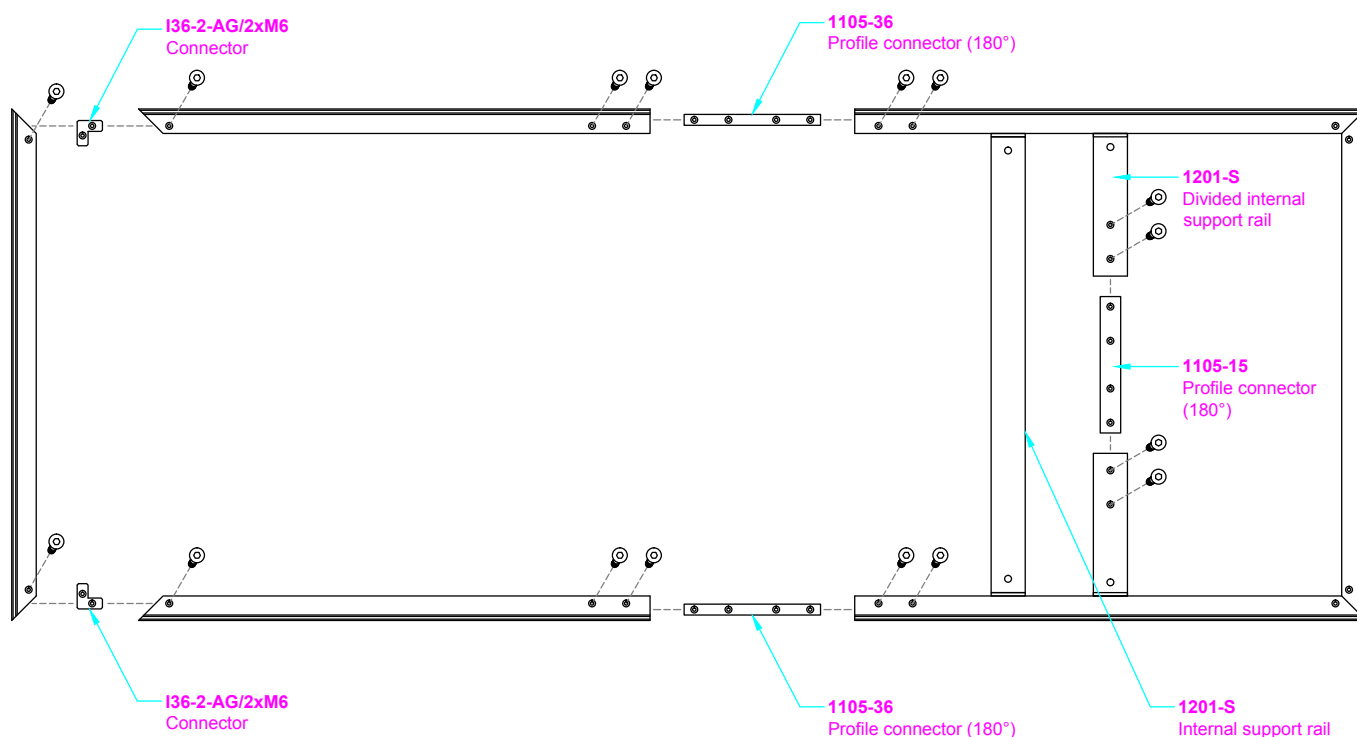

## Accessories:

**Connector**

I36-2-AG/2xM6

**Handle**

EL-HANDLE

**Profile connector (180°)**

1105-36

**Internal support rail**

1201-S

# How to work with Fabric Frames

Valid for profiles:

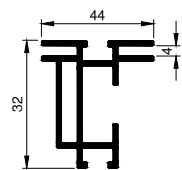

SF-44-2A

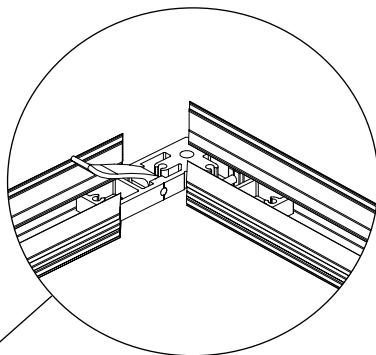

## Assembly instructions:

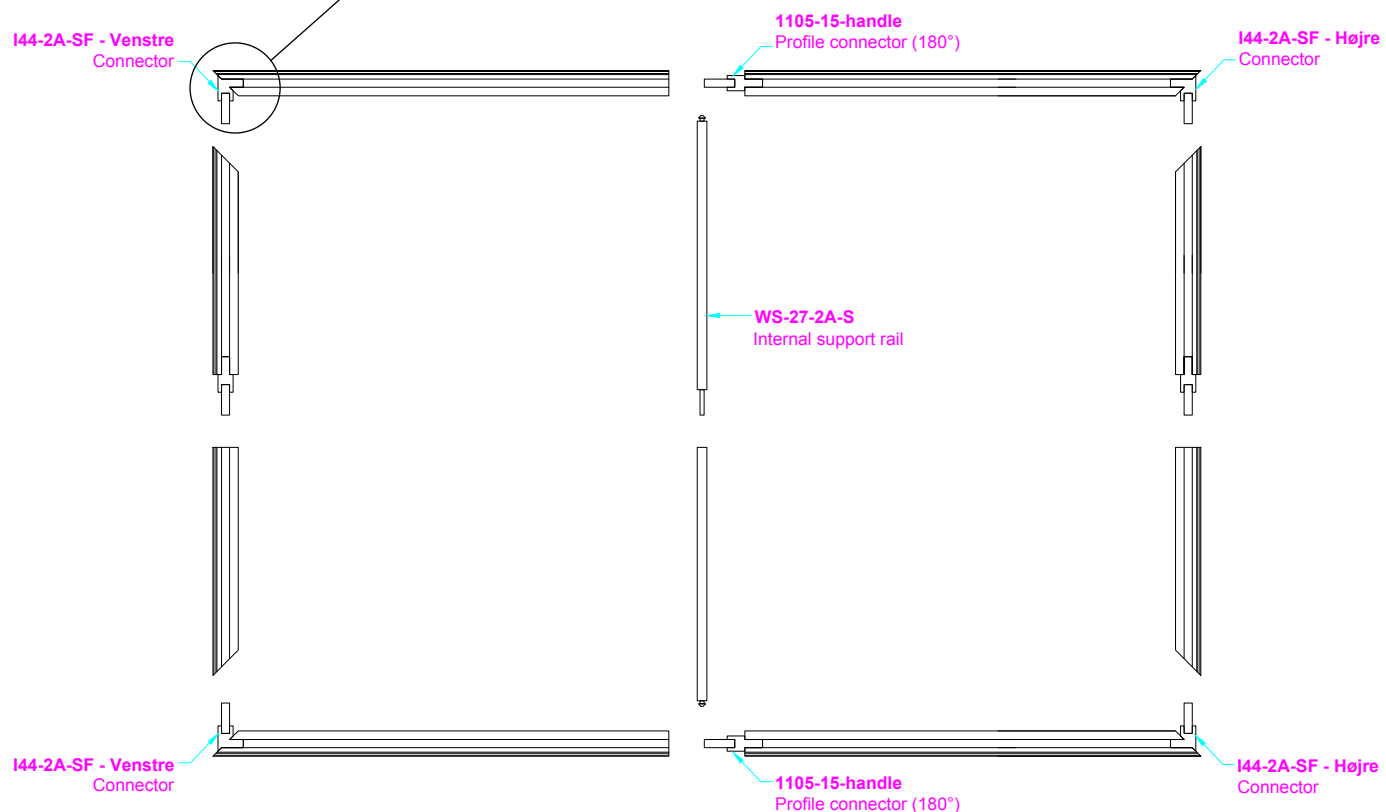

## Accessories:

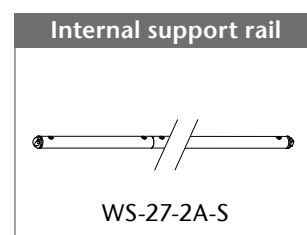
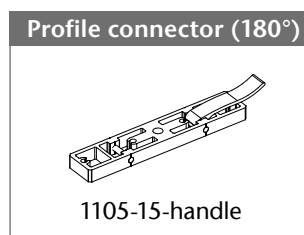
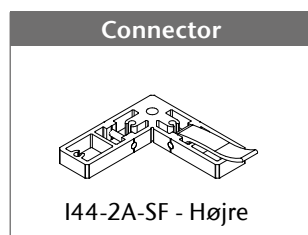
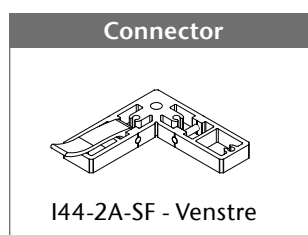



# How to work with Fabric Frames

Valid for profiles:

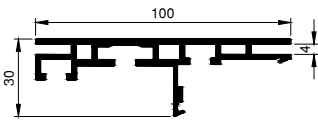

SF-44-100\*

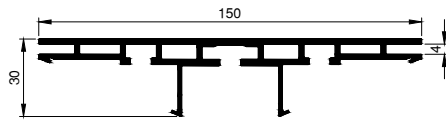

SF-44-150-2\*

\*can be fitted with 110-230V 6x3W LED modules

Mounting of RC36-5 in SF-44-150-2  
placed between LED-modules

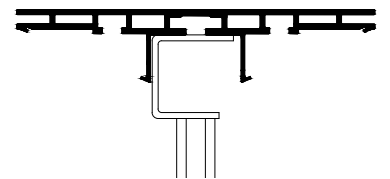

Mounting of 1201-S in SF-44-100  
placed in back side

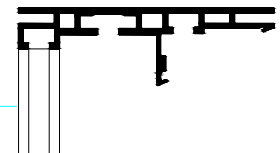

## Assembly instructions:

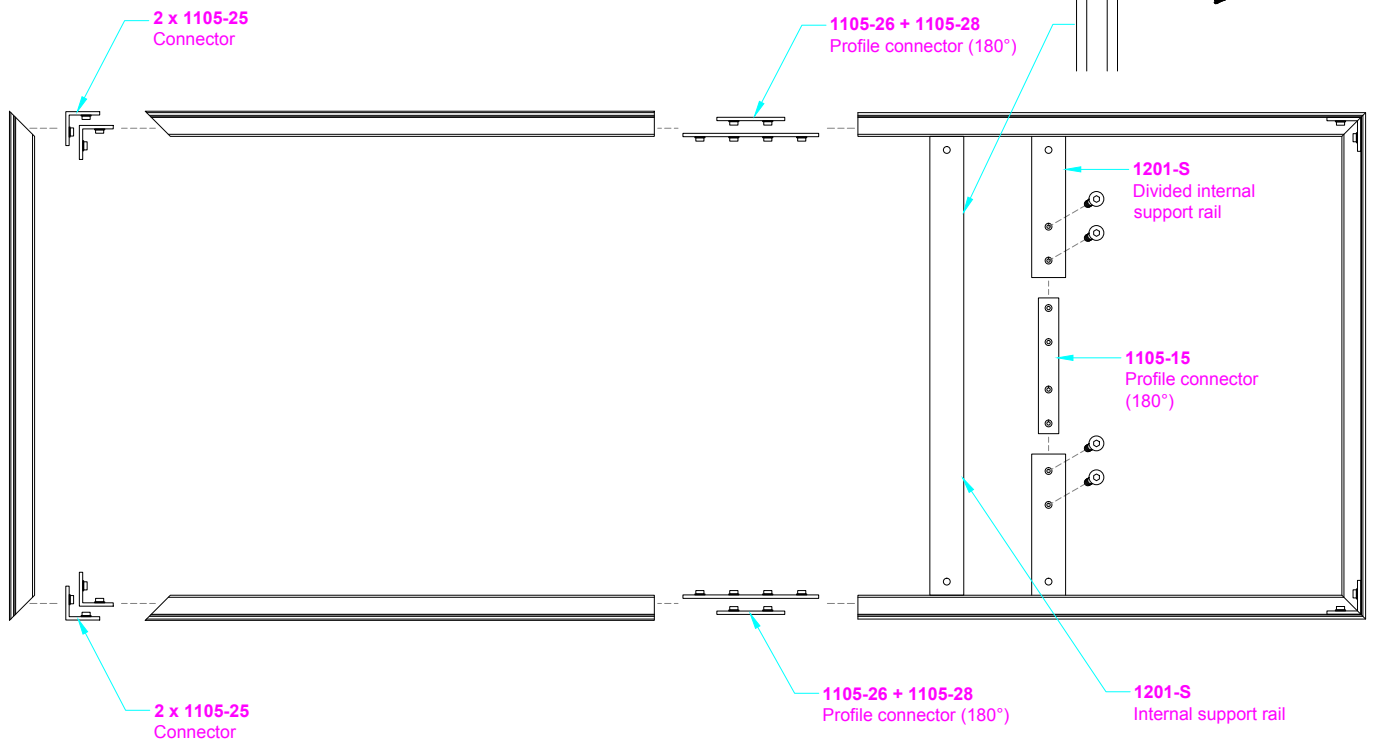

## Accessories:

**Connector**

1105-25

**Profile connector (180°)**

1105-26 + 1105-28

**Internal support rail**

1201-S

**Internal support rail**

RC36-5 + 1105-32

Only for SF-44-100

Only for SF-44-150-2

# How to work with Fabric Frames

Valid for profiles:

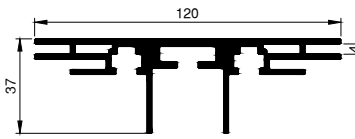

SF-44-120-2\*

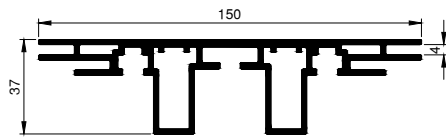

SF-44-150\*

\*can be fitted with 5x3W and 3x3W LED modules

Mounting of WS-27-S in SF-44-150 placed between LED-modules

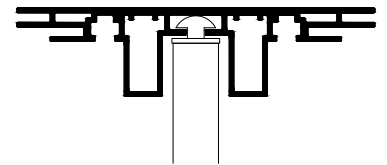

Mounting of WS-27-S in SF-44-120-2 placed between LED-modules

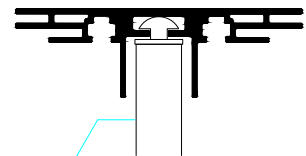

## Assembly instructions:

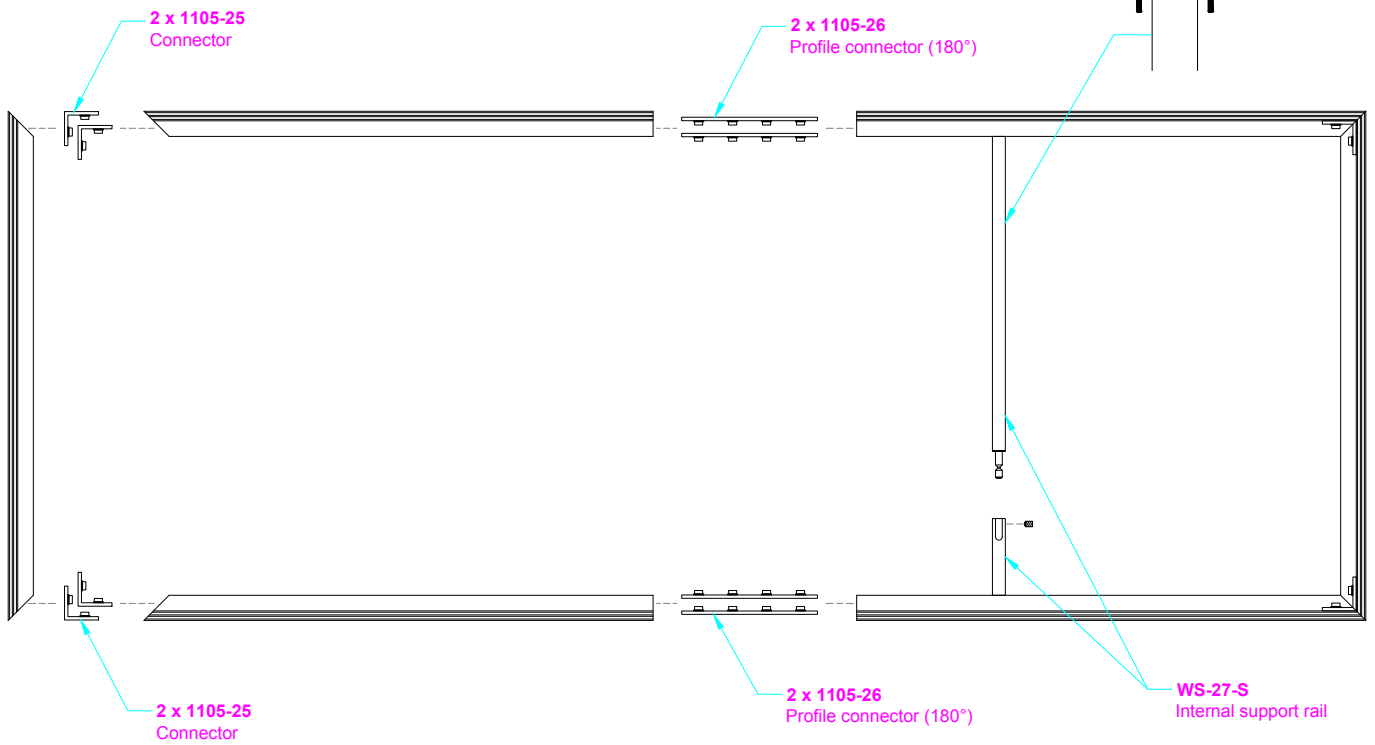

## Accessories:

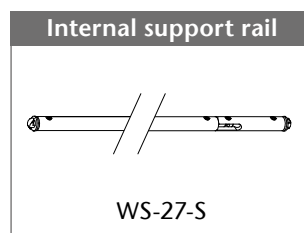
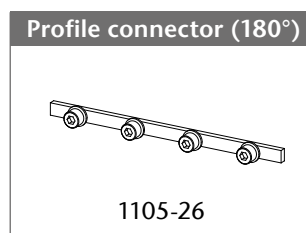
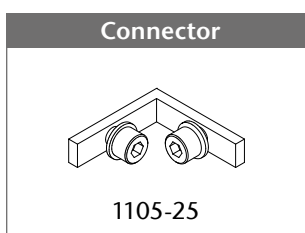

# How to work with Fabric Frames

Valid for profiles:

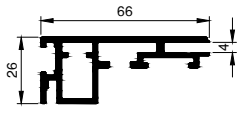

BLF-68



BLF-L

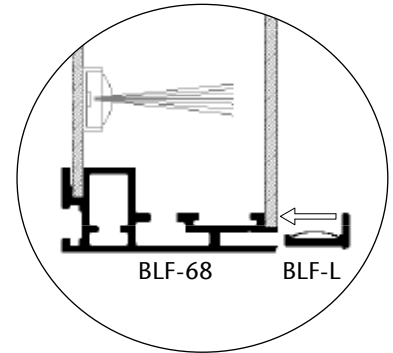
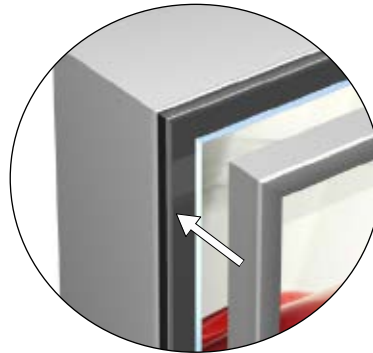

Assembly instructions:

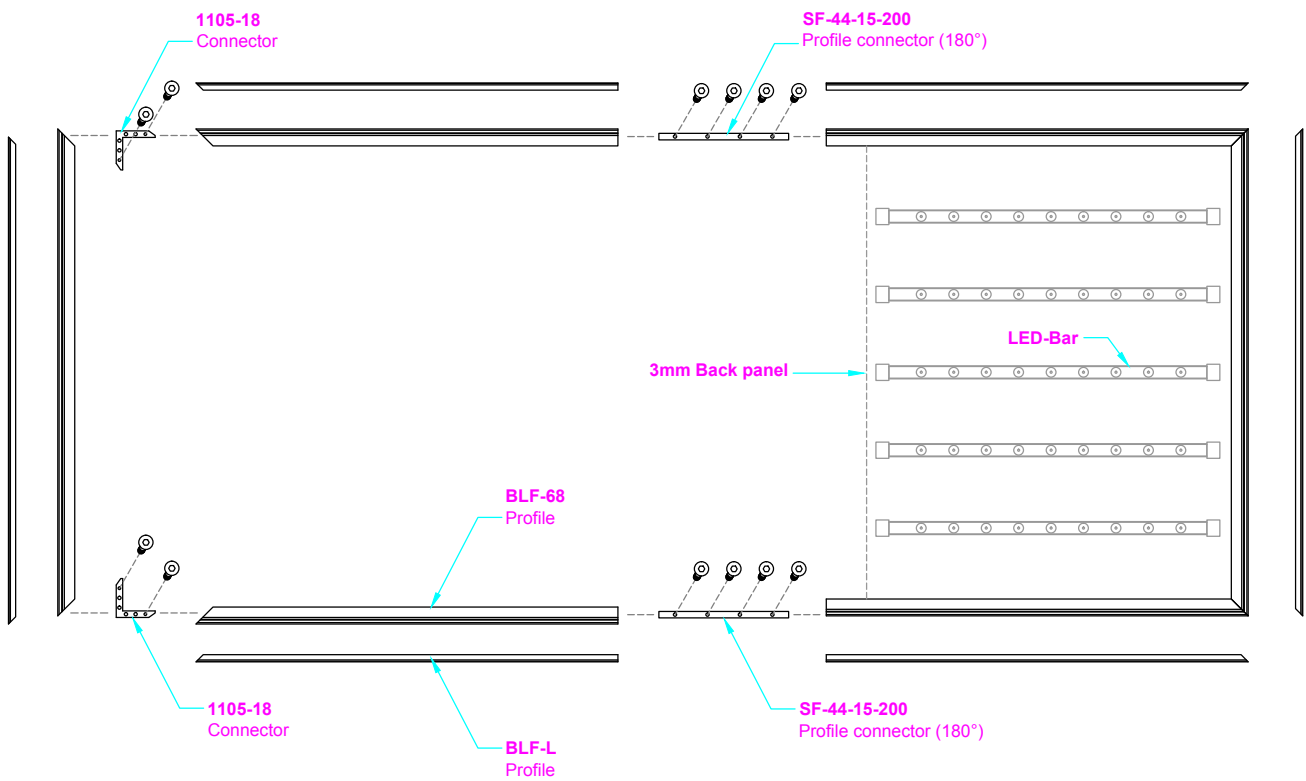

Accessories:

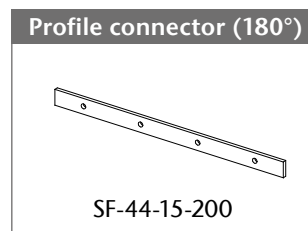
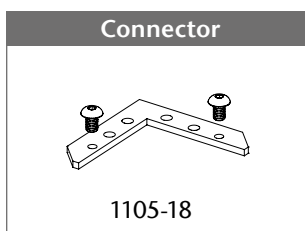

# How to work with Fabric Frames

Valid for profiles:

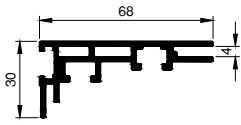

SF-44-68-2  
Top & bottom profile

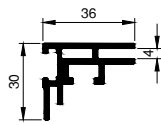

SF-36-1  
Side profile

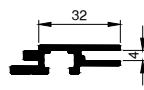

SF-32-EP  
Extensions profile

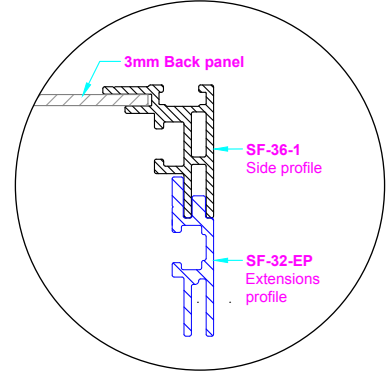
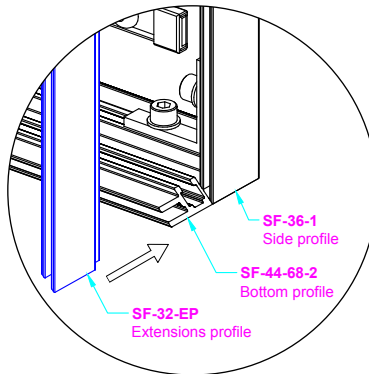
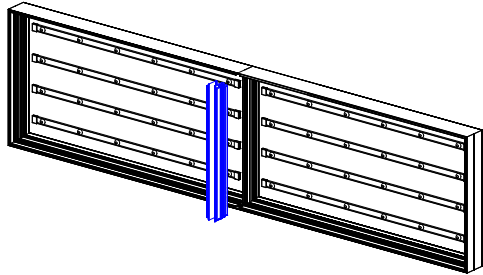

Assembly instructions:

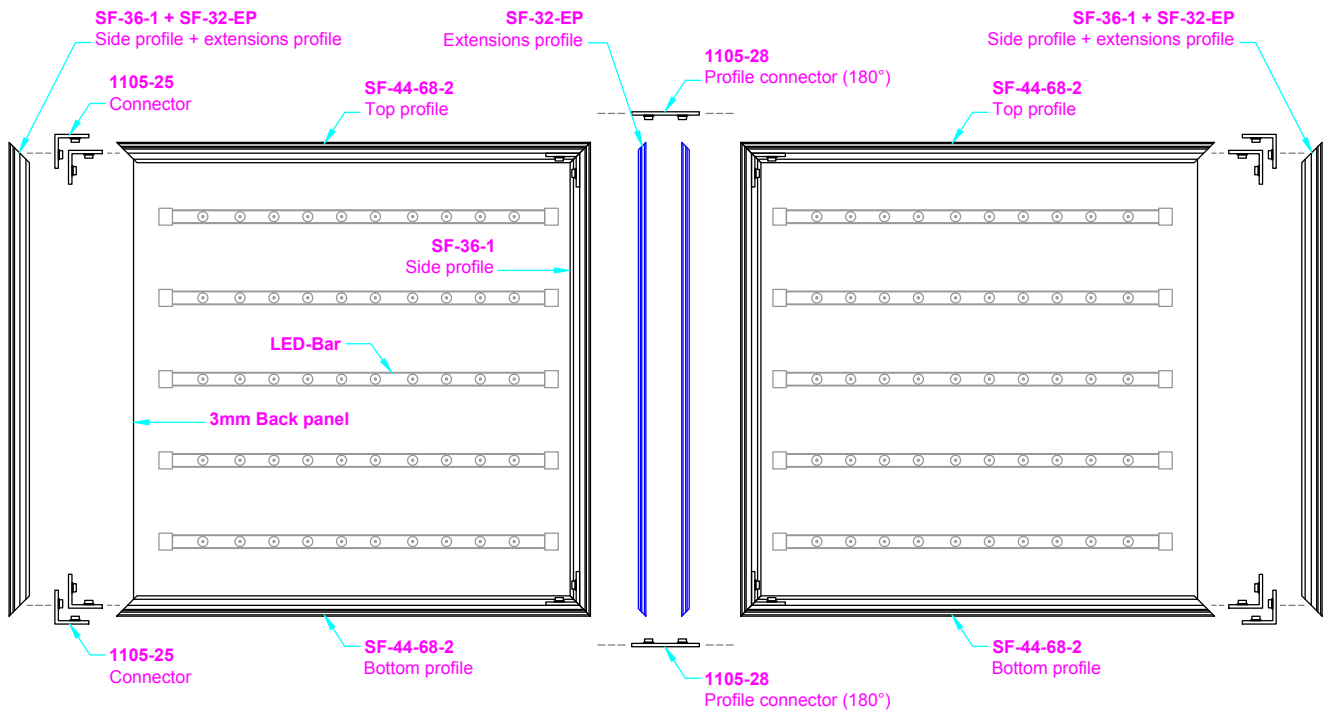

Accessories:

**Connector**

1105-25

**Profile connector (180°)**

1105-28

**Hook bracket**

Hægtebeslag Venstre

**Hook bracket**

Hægtebeslag Højre

# How to work with Fabric Frames

Valid for profiles:

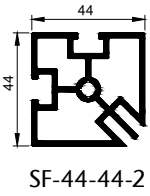

Example:

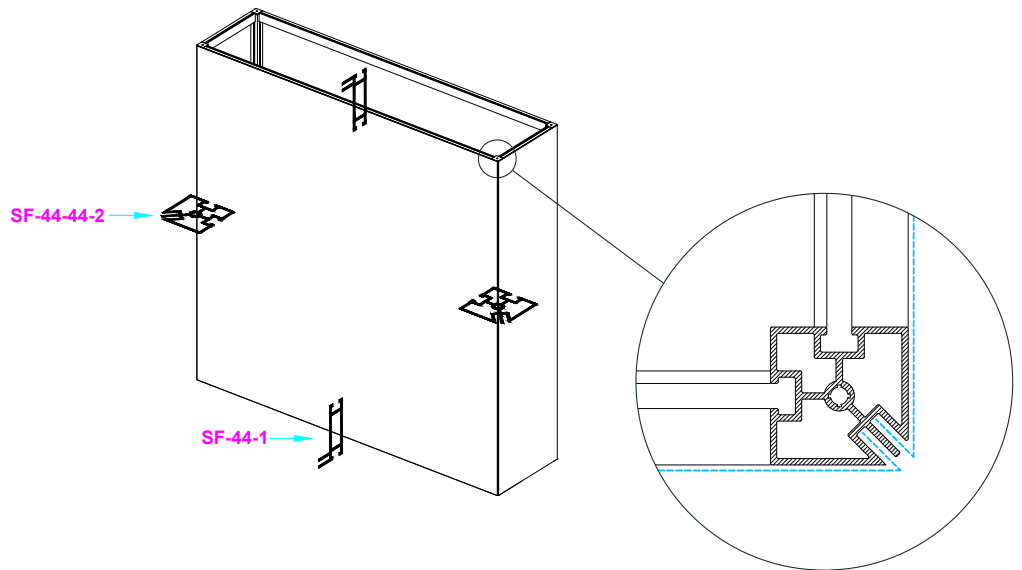

Assembly instructions:

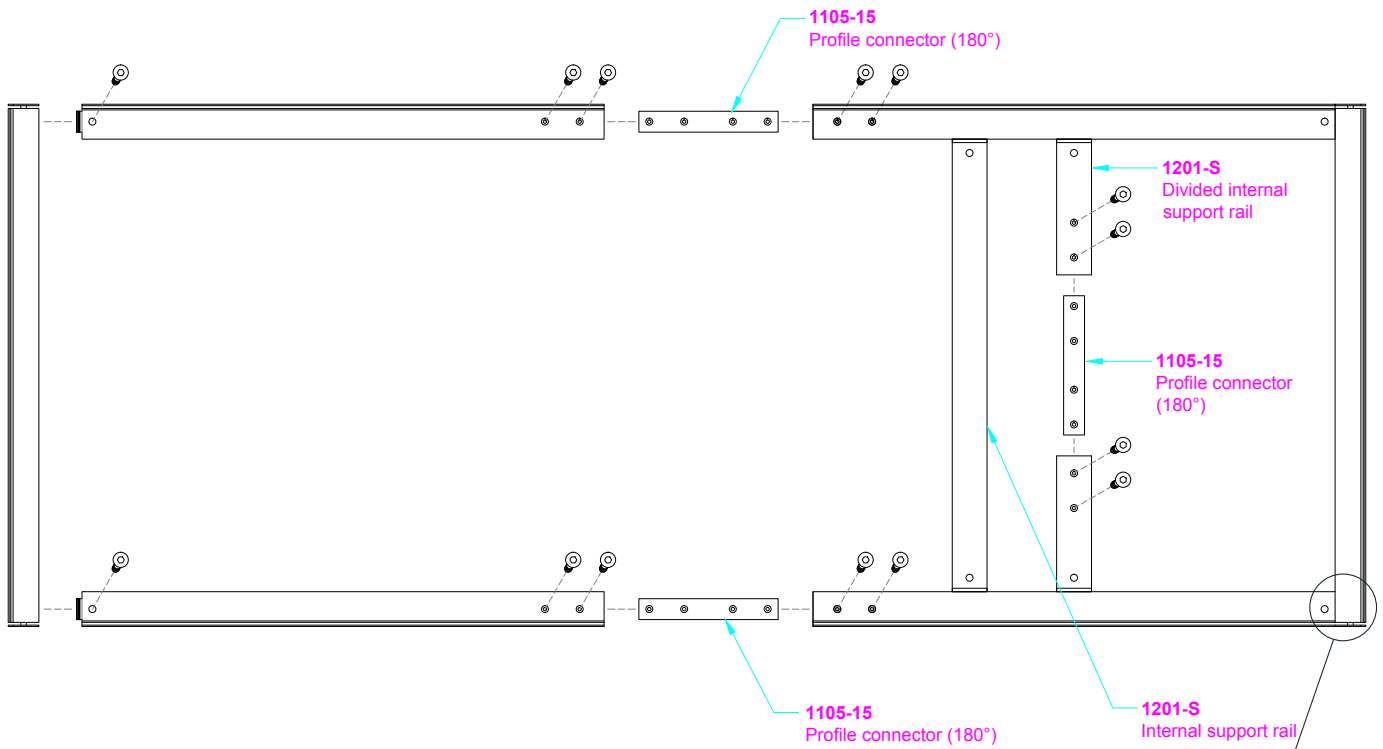

Accessories:

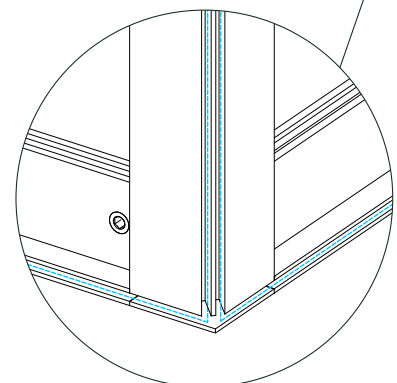
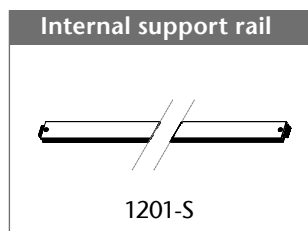
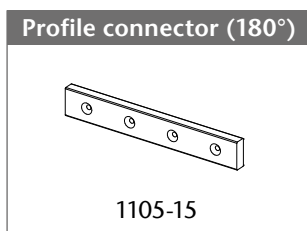

# How to work with Fabric Frames

Valid for profiles:

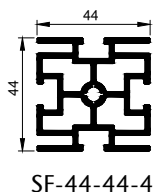

Example:

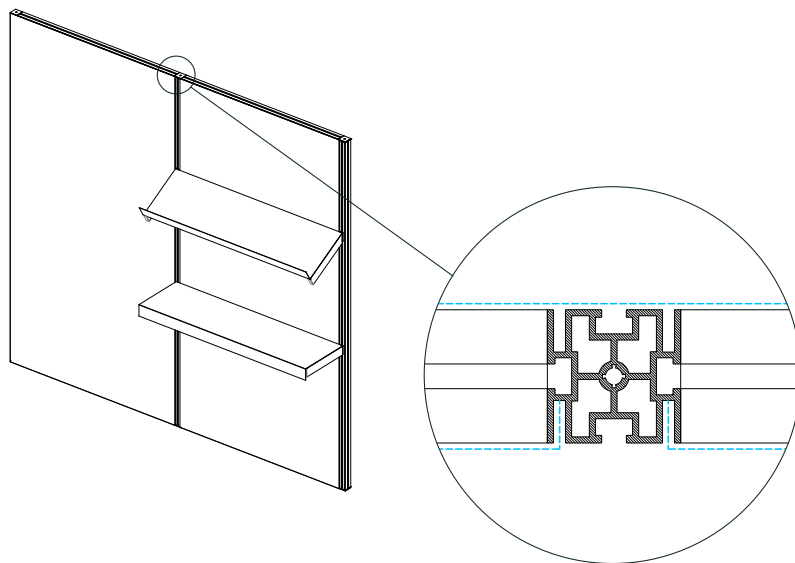

Assembly instructions:

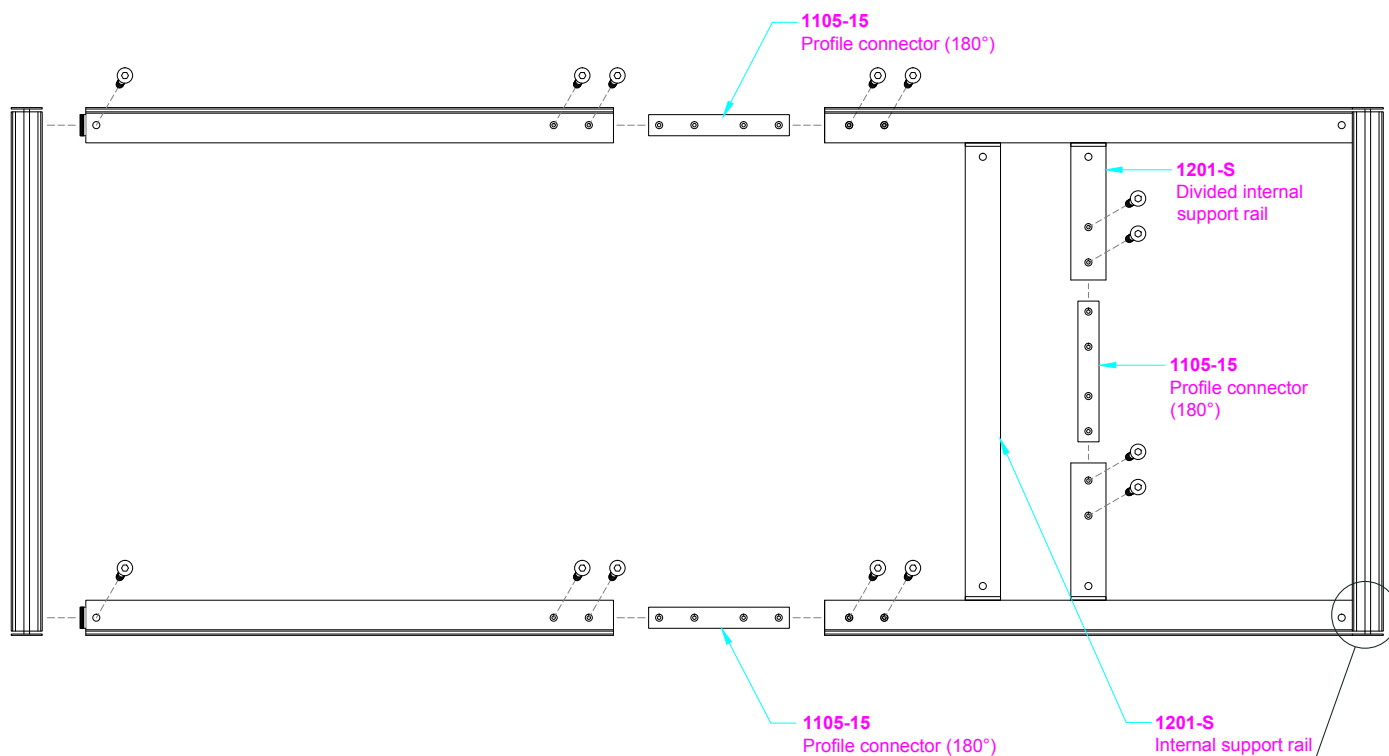

Accessories:

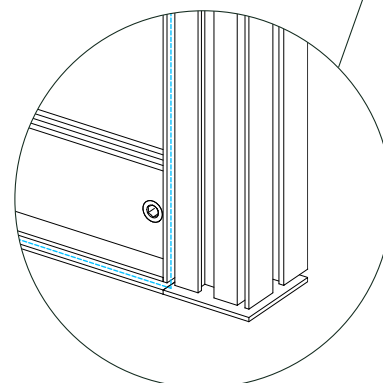
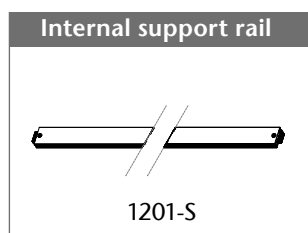
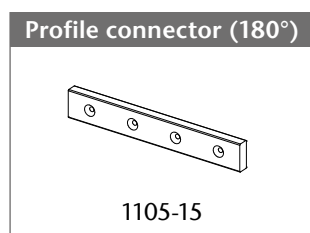

# Frame construction

SF-44-1

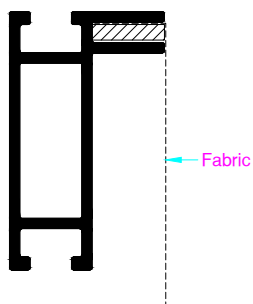

SF-44-2

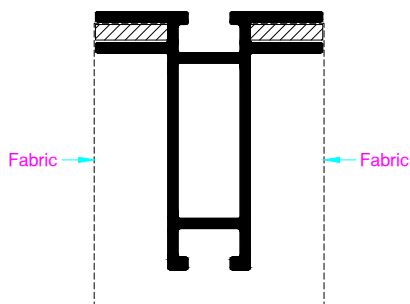

SF-44-2-C

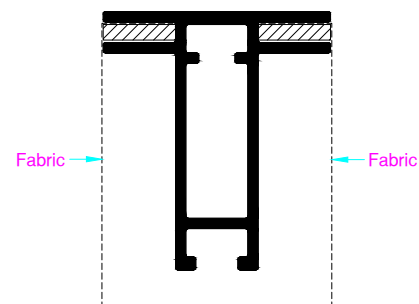

SF-44-4 **LED: 12 V**

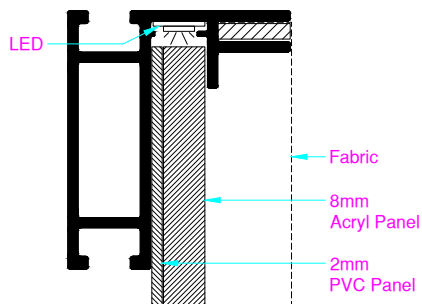

SF-44-5 **LED: 12 V**

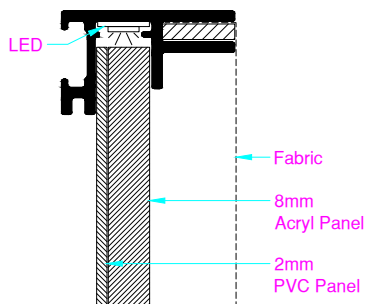

SF-44-6

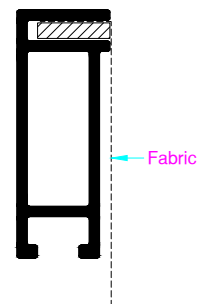

SF-44-7

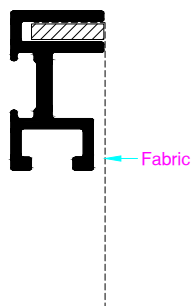

SF-44-8

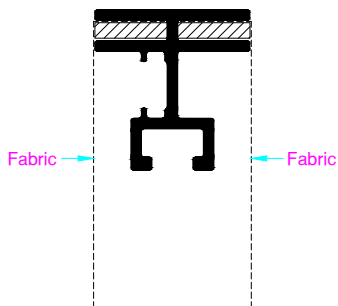

SF-44-9

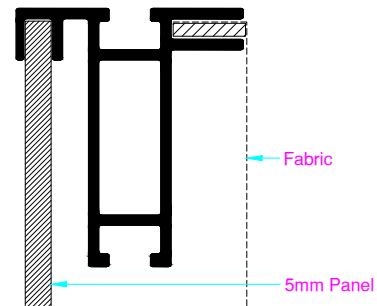

SF-44-10 **ACOUSTIC**

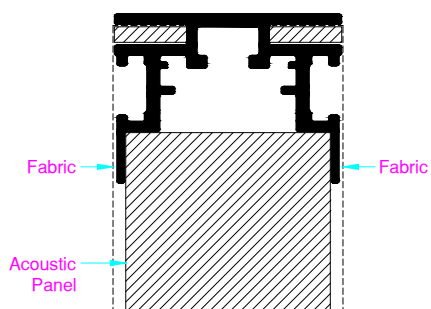

SF-44-2A

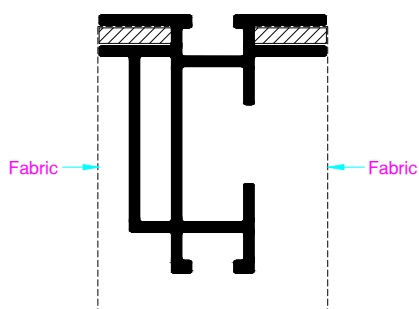

SF-36-2

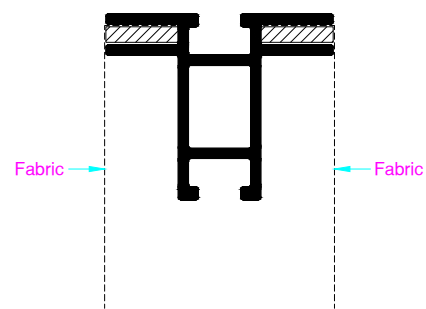

# Frame construction

**BLF-68** LED: 24 V

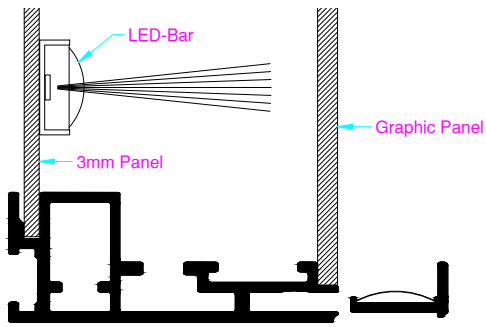

**SF-44-68-2** LED: 24 V

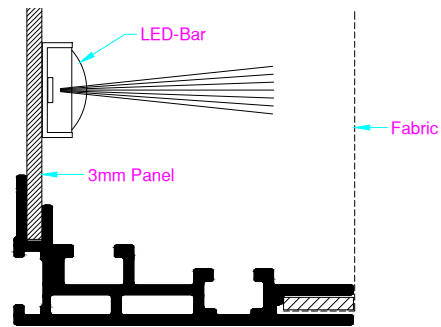

**SF-44-85** LED: 24 V

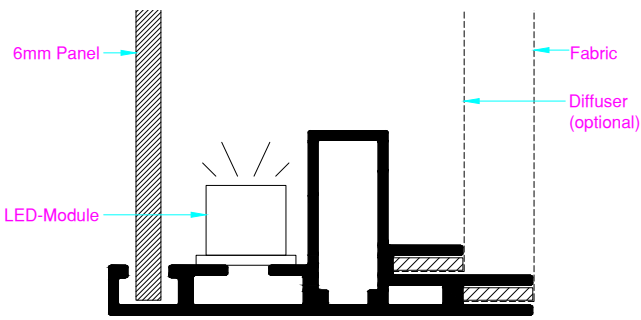

**SF-44-100** LED: 110-230 V

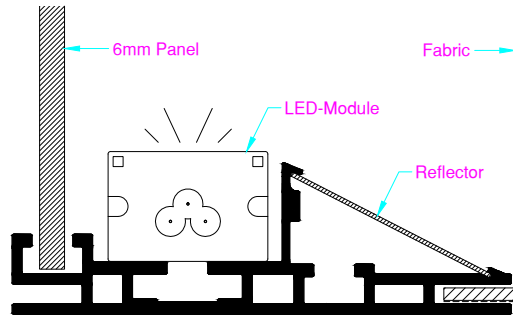

**SF-44-120** LED: 24 V

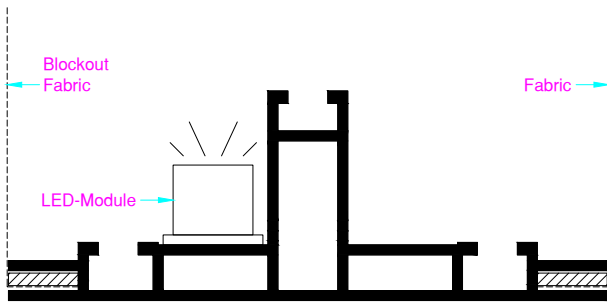

Single sided

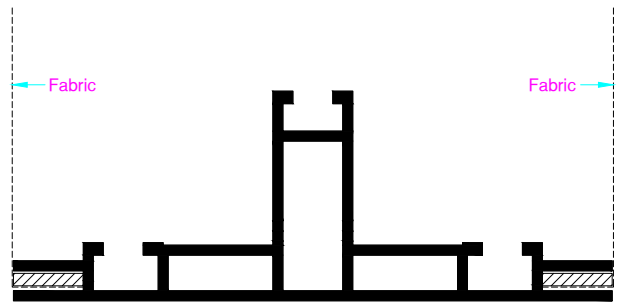

Double sided

**SF-44-120-2** LED: 24 V

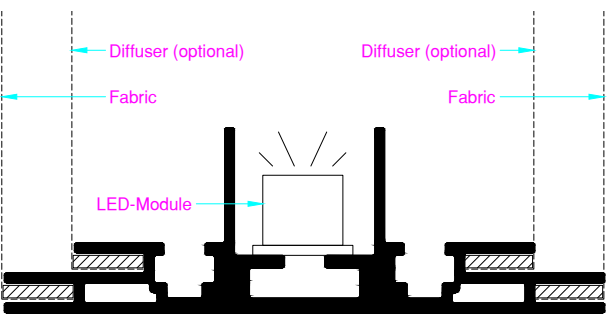

Double sided



# Frame construction

SF-44-150 **LED: 24 V**

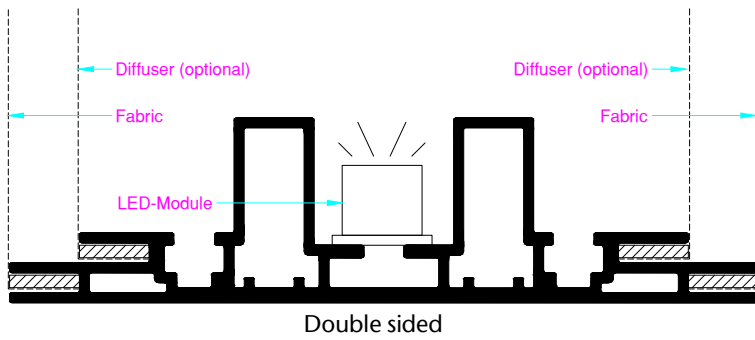

SF-44-150-2 **LED: 110-230 V**

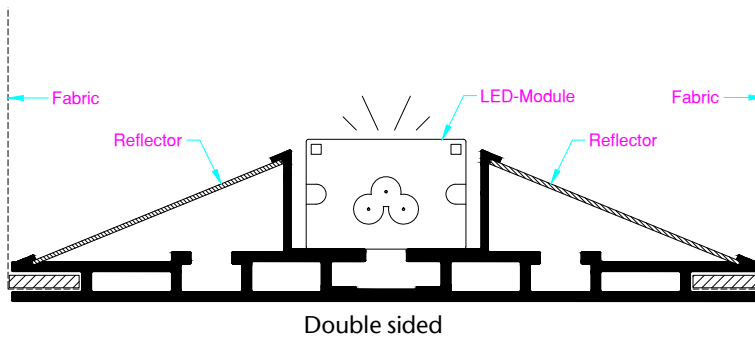

# SF-44-DOOR

The door can be used as left or right hinged

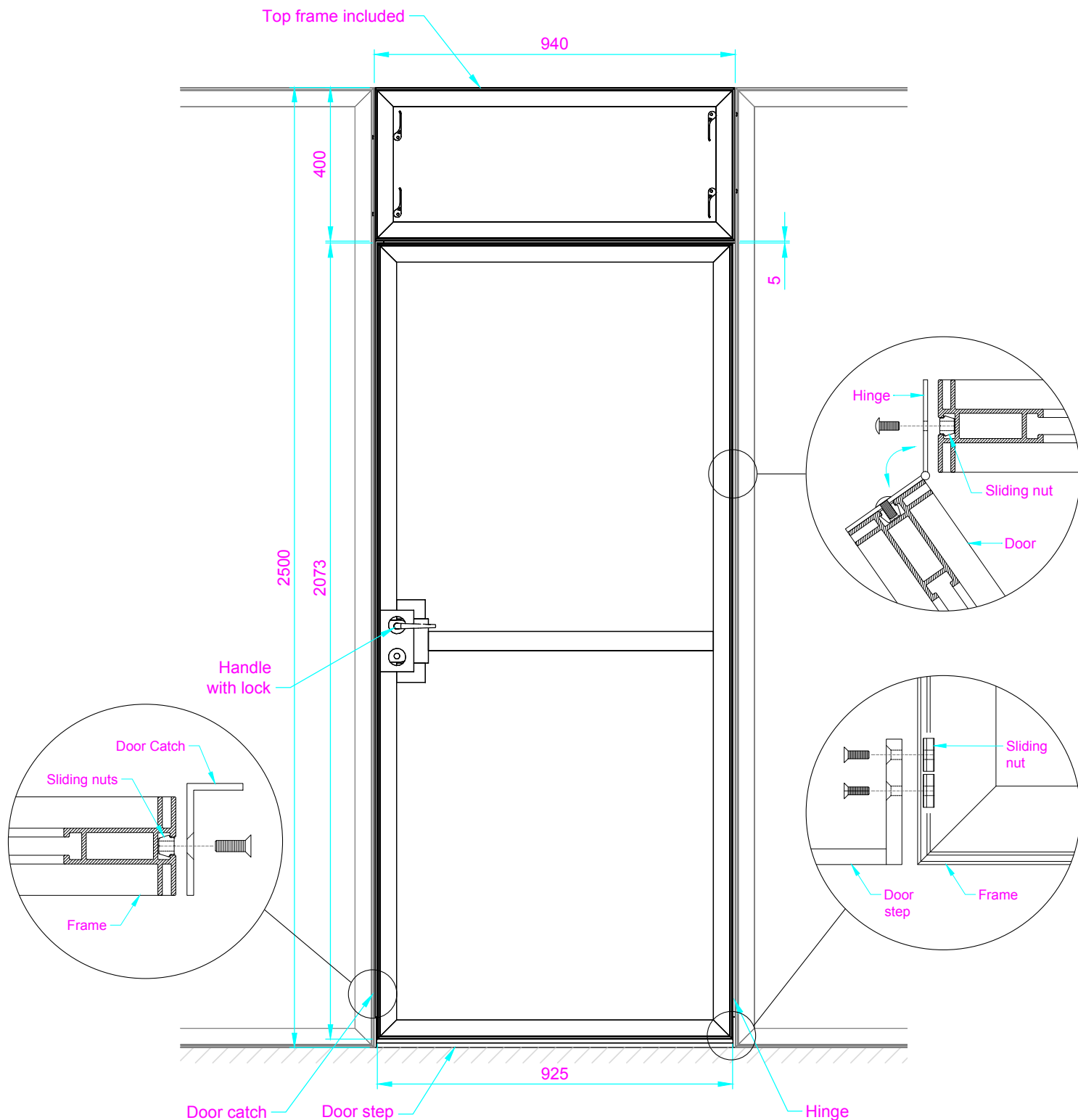

### SF-44-DOOR fabric size:

1 x Door fabric W.925 x H.2073mm

1 x Top frame fabric W.940 x H.400mm

# EL-DOOR-1 & EL-DOOR-2

The door can be used as left or right hinged

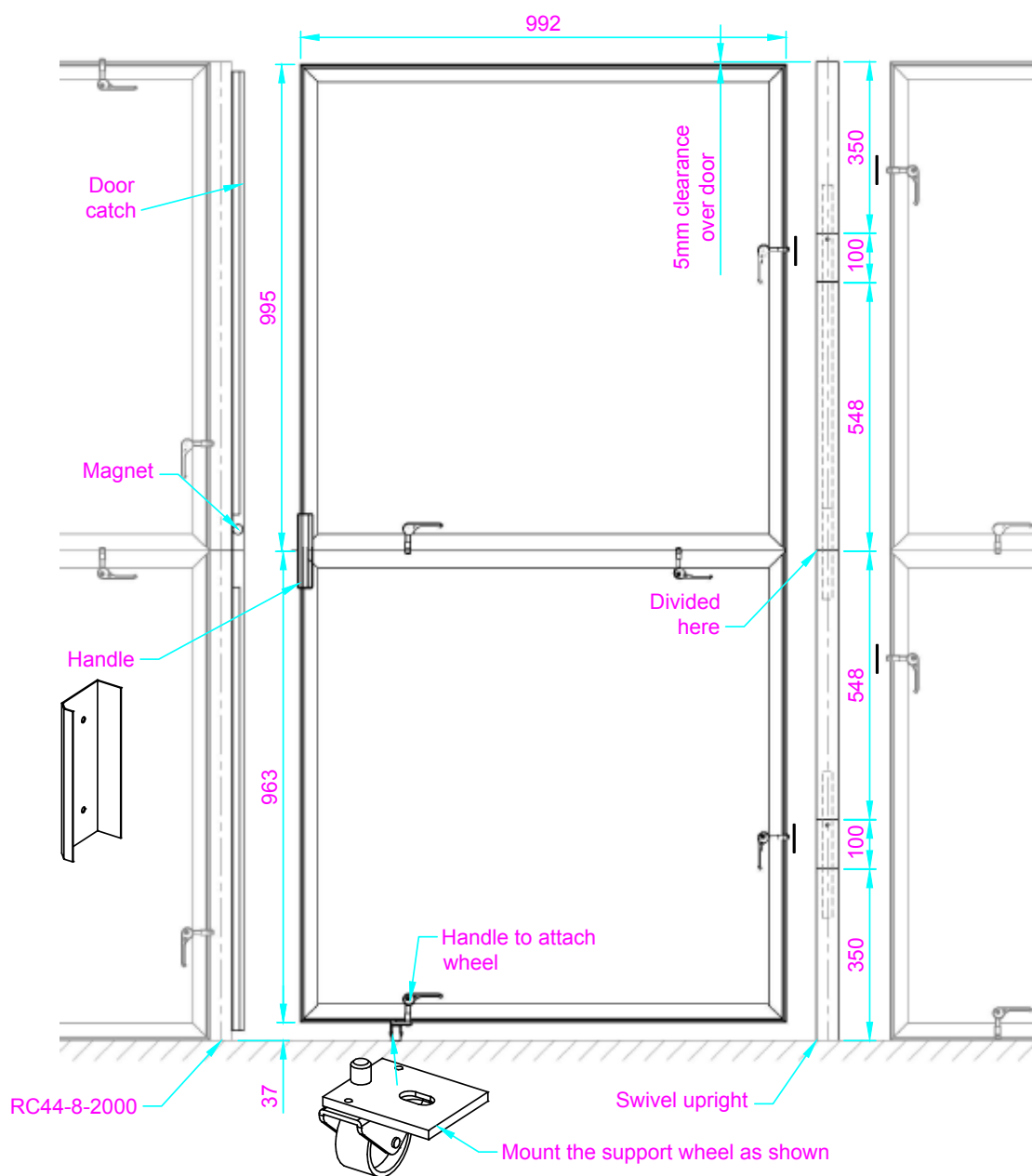

**EL-DOOR-1 fabric size:**

1 x Fabric W.992 x H.1958mm

**EL-DOOR-2 fabric size:**

1 x Top fabric W.992 x H.995mm  
 1 x Bottom fabric W.992 x H.963mm

# EL-DOOR-3

The door can be used as left or right hinged

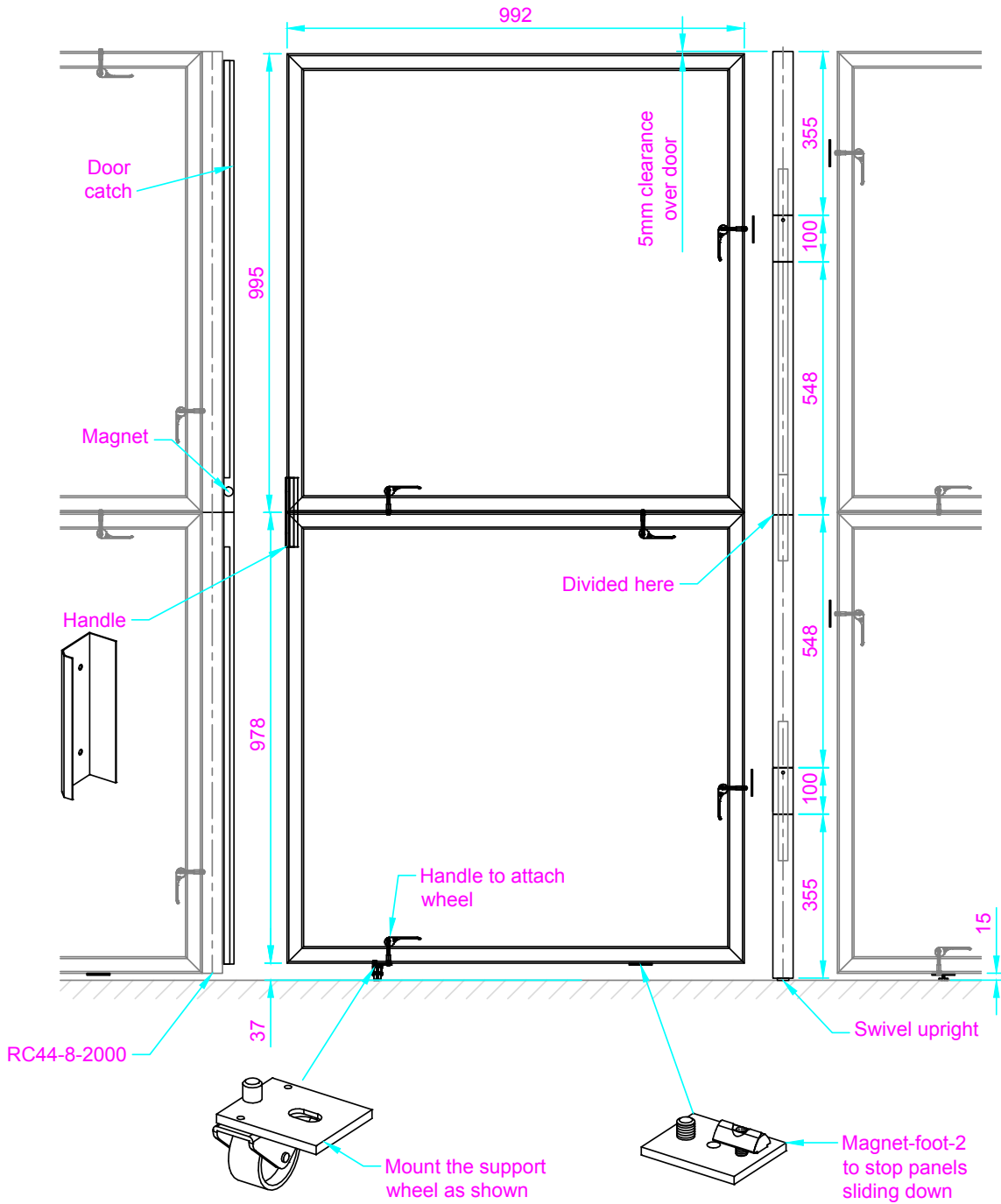

### EL-DOOR-3 graphic size:

1 x Top panel W.992 x H.995mm

1 x Bottom panel W.992 x H.978mm

# TV bracket

Valid for profiles:

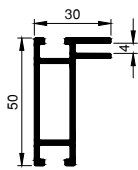

SF-44-1

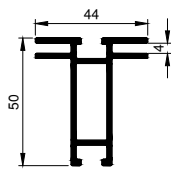

SF-44-2

## Assembly instructions:

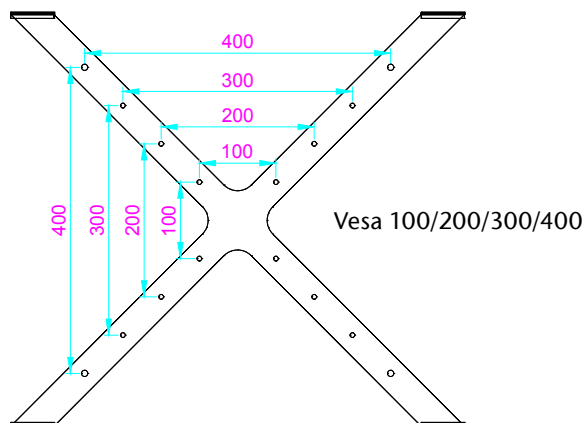
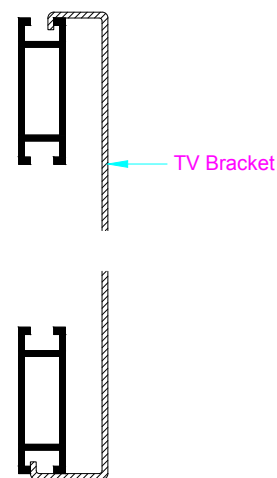
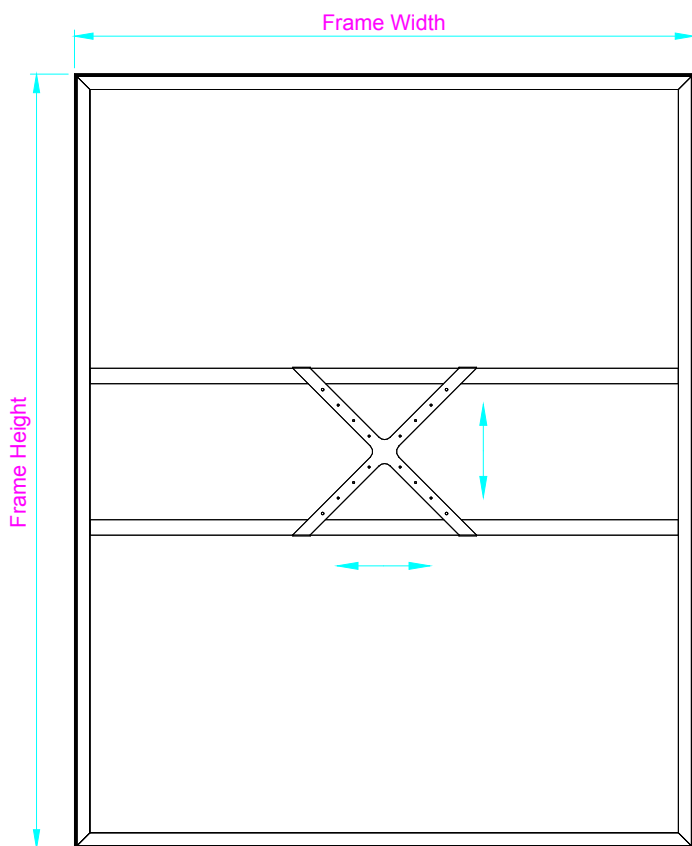

# How to work with Fabric Frames

Valid for profiles:

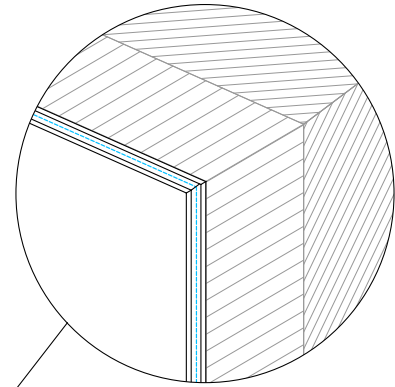
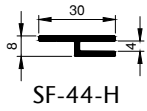

Frame in miter joint

Assembly instructions:

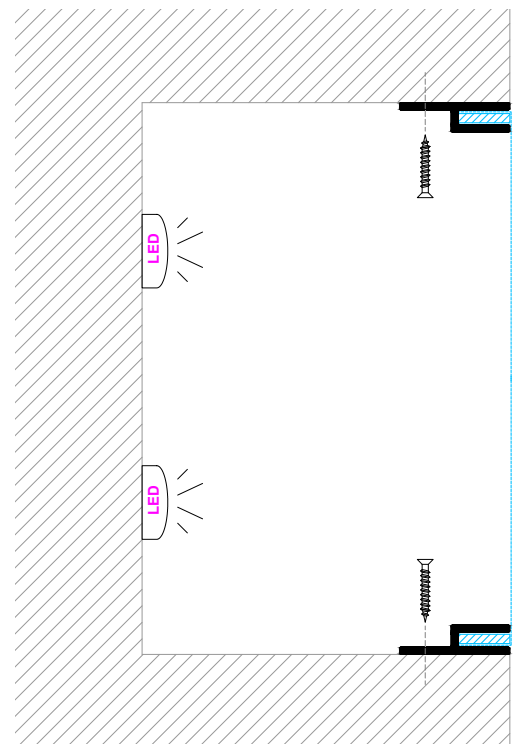
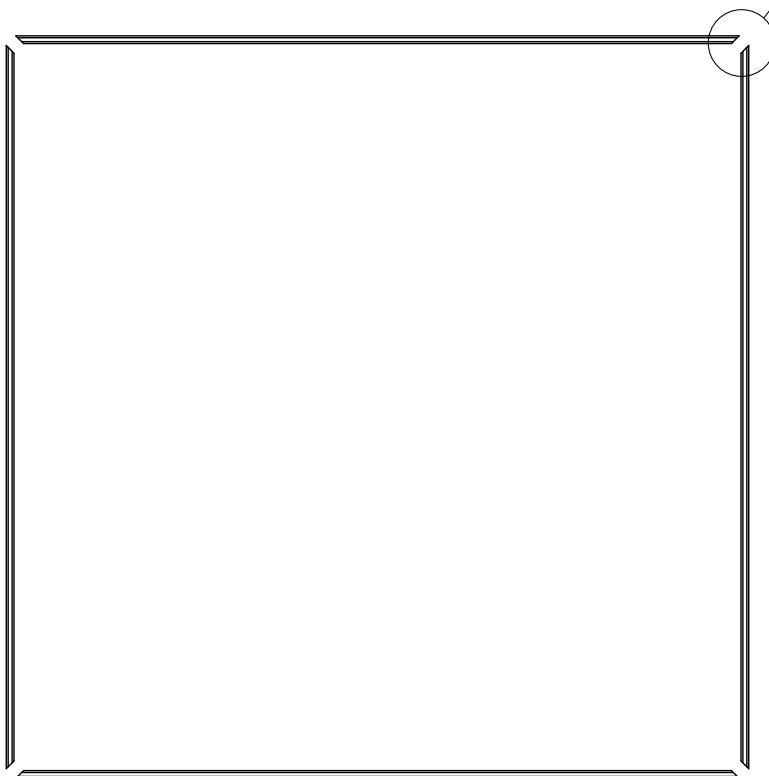

# Wall brackets

## SF-44-3-15x40

Fits to: SF-44-1, SF-44-4, SF-44-6 & SF-44-7

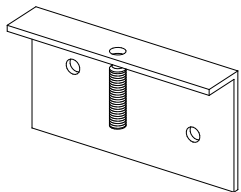

Mounting:

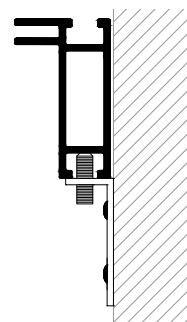

## SF-44-3-8x40

Fits to: SF-44-5, SF-44-10, SF-44-68-2, SF-36-1, SF-44-100 & BLF-68

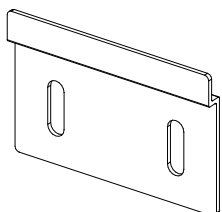

Mounting:

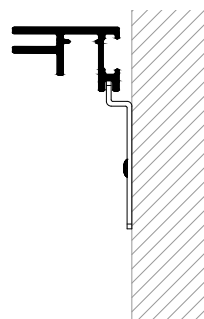

## SF-44-4-30x60

Fits to: SF-44-2, SF-44-2-C & SF-36-2

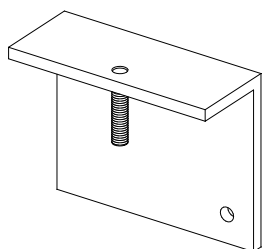

Mounting:

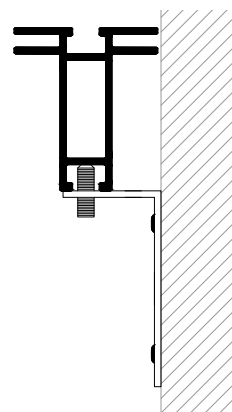

## SF-44-85-40-13

Fits to: SF-44-85, SF-44-100

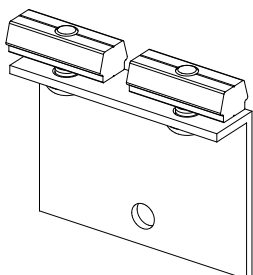

Mounting:

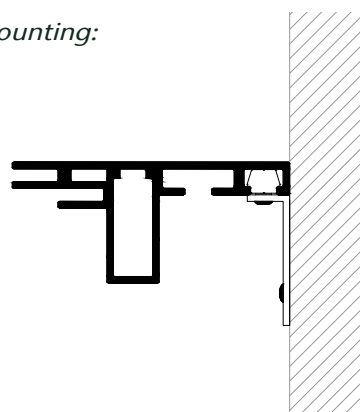

# Steel bases

## WSF-SFS 250x100x5mm

Fits to: SF-44-1, SF-44-2, SF-44-4, SF-44-9, SF-44-10 & SF-36-2

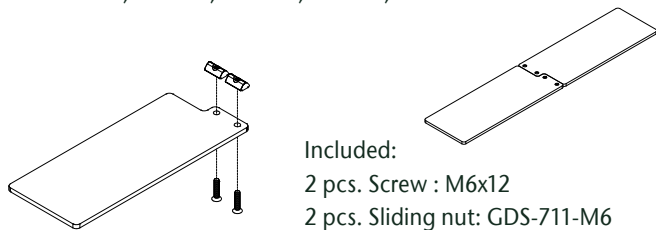

Included:  
2 pcs. Screw : M6x12  
2 pcs. Sliding nut : GDS-711-M6

### Mounting:

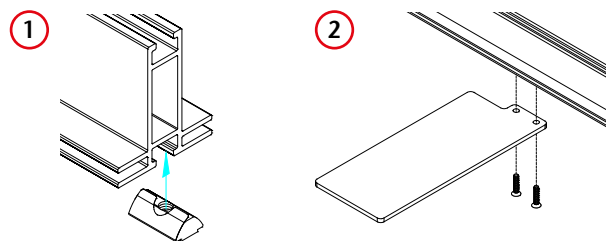

## WSF-SFS-2 500x100x5mm

Fits to: SF-44-1, SF-44-2, SF-44-4, SF-44-9, SF-44-10 & SF-36-2

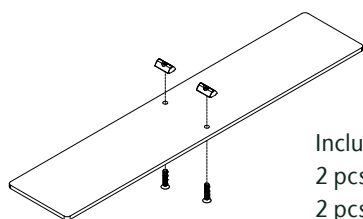

Included:  
2 pcs. Screw : M6x12  
2 pcs. Sliding nut : GDS-711-M6

### Mounting:

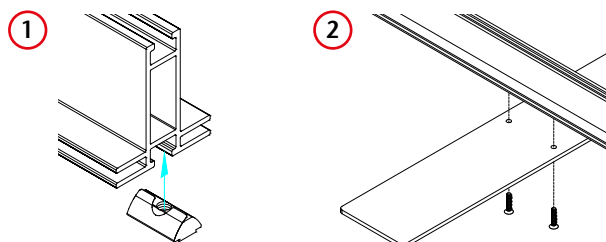

## WSF-SFS-3 500x100x5mm

Fits to: SF-44-85, SF-44-120

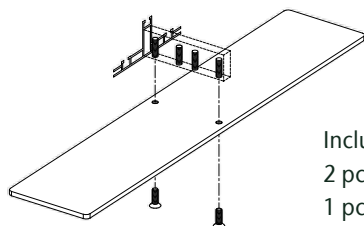

Included:  
2 pcs. Screw: M6x30  
1 pcs. Insert: SP12-30-100/G4xM6

### Mounting:

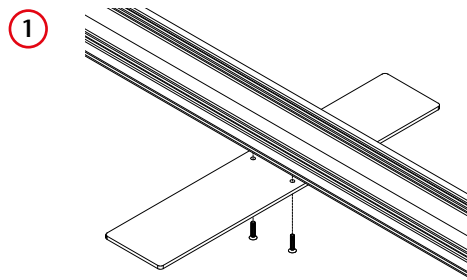

## WSF-SFS-4 500x100x5mm

Fits to: SF-44-100, SF-44-120-2, SF-44-150 & SF-44-150-2

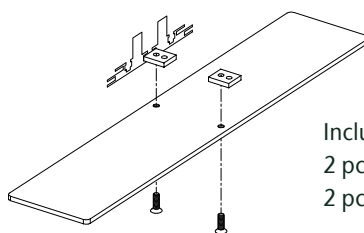

Included:  
2 pcs. Screw: M6x16  
2 pcs. Insert: SF711-120-150

### Mounting:

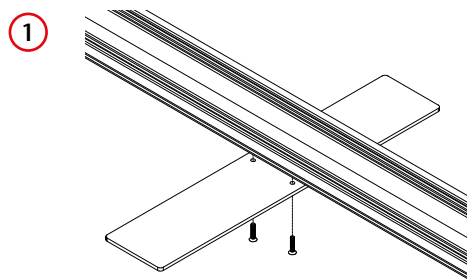

## WSF-SFS-5 250x100x5mm

Fits to: SF-44-85, SF-44-120

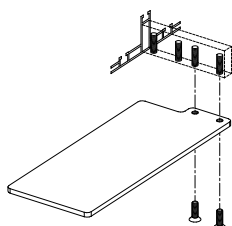

Included:  
2 pcs. Screw : M6x30  
1 pcs. Insert : SP12-30-100/G4xM6

### Mounting:

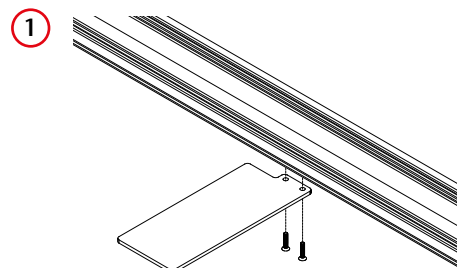



# Steel bases

## WSF-SFS-6 484x100x5mm

Fits to: SF-44-85, SF-44-120

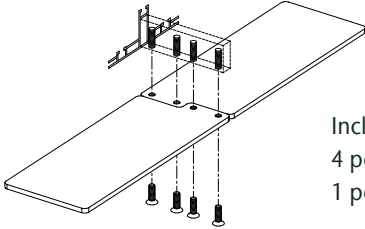

Included:  
4 pcs. Screw : M6x30  
1 pcs. Insert : SP12-30-100/G4xM6

### Mounting:

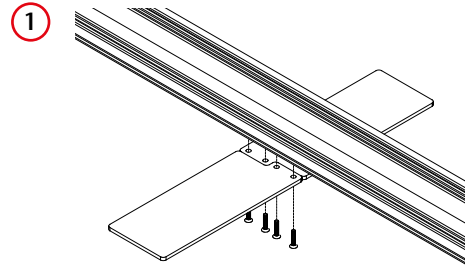

## WSF-SFS-7 250x100x5mm

Fits to: SF-44-120-2 & SF-44-150

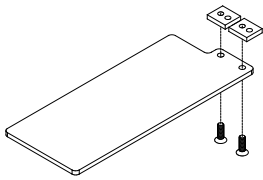

Included:  
2 pcs. Screw: M6x16  
2 pcs. Insert: SF711-120-150

### Mounting:

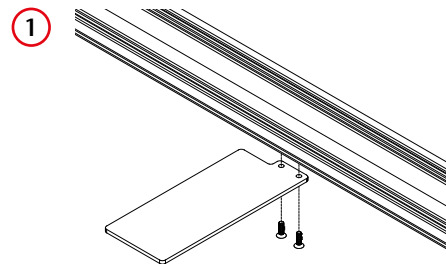

## WSF-Handle 500x80x5mm

Fits to: SF-44-1, SF-44-2, SF-44-2A, SF-44-4, SF-44-9 & SF-36-2

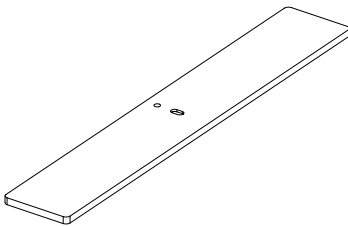

### Mounting:

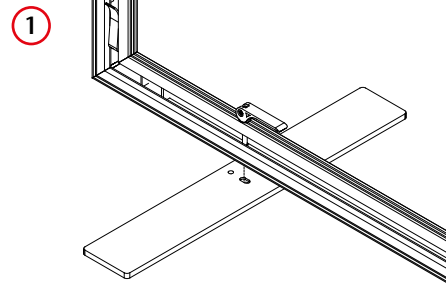

## WSF-Frame Ø340x5mm

Fits to: SF-44-1, SF-44-2, SF-44-4, SF-44-9, SF-44-10 & SF-36-2

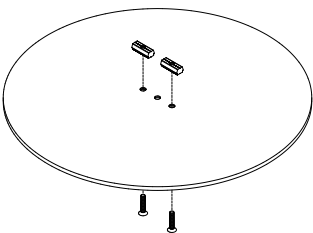

Included:  
2 pcs. Screw : M6x12  
2 pcs. Sliding nut: GDS-711-M6

### Mounting:

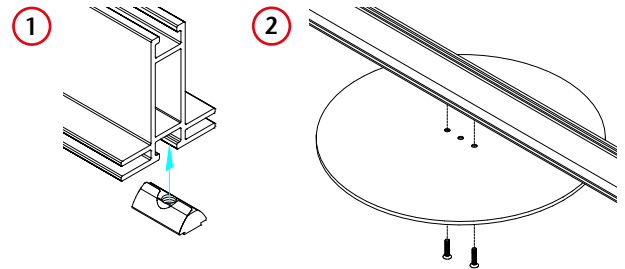

## WSF-SFS-10 335x335x15mm - weight: 10 kg.

Fits to: SF-44-1, SF-44-4, SF-44,6, SF-44-7, SF-44-9, SF-44-85 & SF-44-100

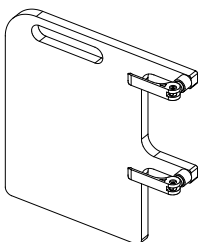

Included:  
2 pcs. Handle: GDS-HANDLE

### Mounting:

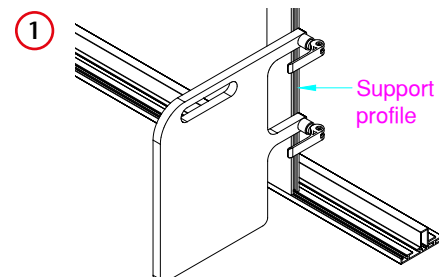

# Steel bases

## WSF-SFS-11 500x100x5mm

Fits to: SF-44-1, SF-44-2, SF-44-2A, SF-44-4, SF-44-9 & SF-36-2

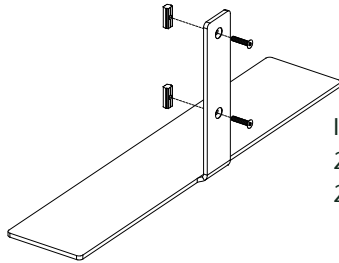

Included:  
2 pcs. Screw : M6x12  
2 pcs. Sliding nut: GDS-711-M6

*Mounting:*

①

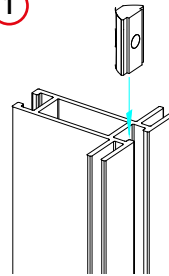

②

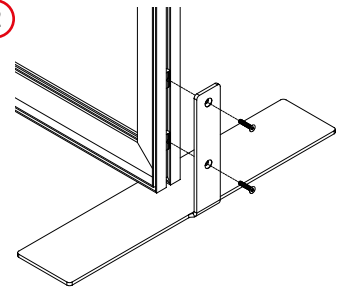

# Fabric

## Technical info:

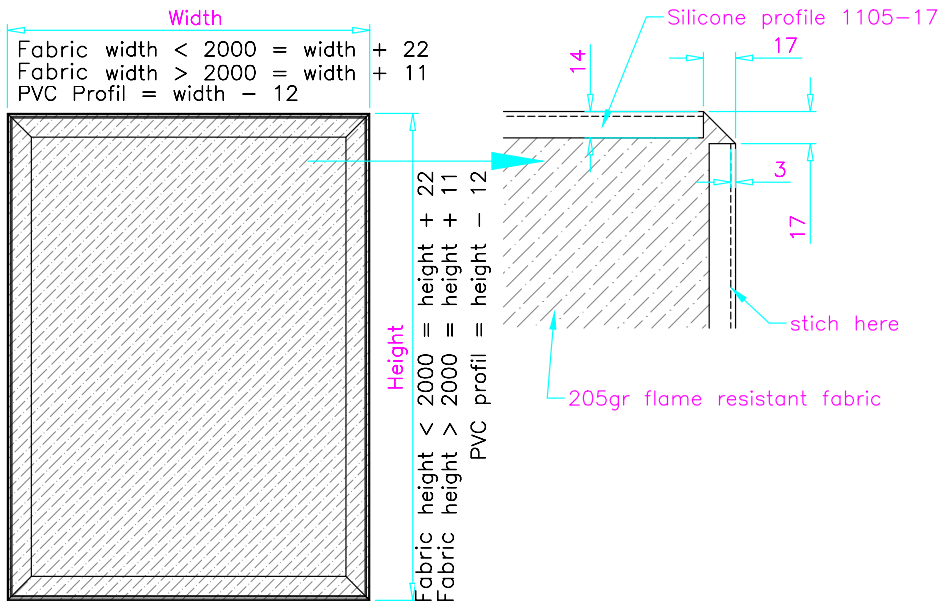

## Printfiles:

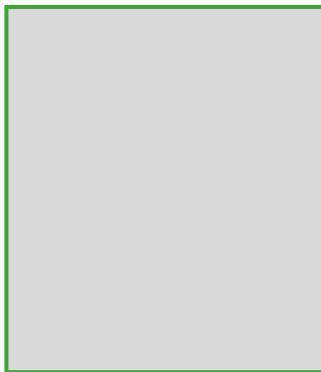

**Smartframe:**  
 Graphic dimensions = external dimensions of the frame

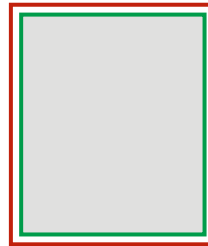

### Graphics for print:

- Bleed = graphic dimensions plus 40mm on each side
- PDF in minimum 100 dpi in 1:1
- Colors in CMYK
- Fonts attached or outlined

## Fitting the fabric:

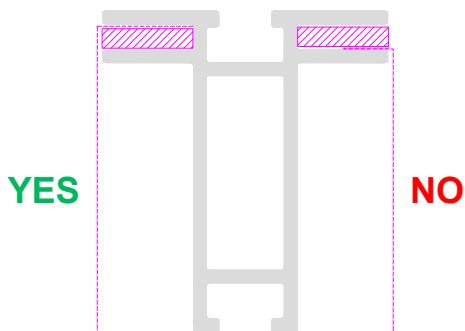

# For more information on



**EASYLOCK-1**  
Modular system for large fabric prints

**SYSTEM STANDEX**

**EASYLOCK-2**  
Modular Fabric Print

**SYSTEM STANDEX**

**EASYLOCK-3**  
Modular Magnetic Panels

**SYSTEM STANDEX**

**EASYLOCK-4**  
Udstillingssystem opbygget uden brug af værktøj

**SYSTEM STANDEX**

**Cobra Expo**  
Modular exhibition system

**SYSTEM STANDEX**

**SmartFrames**  
A modular exhibition system for fabric graphics and other displays

**SYSTEM STANDEX**

**Profile system for fabric graphics**

**SYSTEM STANDEX**

**STANDEX AKUSTIKRAMMER**  
Et standard akustikramme til fremvisning af materialer

**SYSTEM STANDEX**

**LYSKASSER**  
Opbevaringskasser til udstilling af foto og andre materialer

- Subramme
- Udstillingstavle
- Skerm

**SYSTEM STANDEX**

**Hanging canopy signs**  
For the display of fabric graphics

**Baldakiner til stofprint**  
Næstvangst fra loft

**Hængende Baldakiner**  
for Textilbannern  
Vas der Dække hængelånder

**SYSTEM STANDEX**

**Light boxes for graphic panels**

- Standard Light box
- Slim Frame Light box
- Skærm Lightbox

- Alternativt til lyskasser med print på stof, kan systemet monteres til display af print på plastik, papir osv. - pålideligt og nemt at skifte.
- Alternativt kan de monteres efter ønske på væggen. Ved ønske om at montere på væg, kan der monteres en vægmonteringsbeslag.
- Et alternativt til lyskasser med print på stof, kan systemet monteres til display af print på plastik, papir osv. - pålideligt og nemt at skifte.

- Alternativt kan den Standard Lightbox monteres på Standard Lightbox og monteres på væggen. Det skal dog monteres på væggen med en vægmonteringsbeslag.
- Alternativt kan den Standard Lightbox monteres på væggen med en vægmonteringsbeslag.

Please contact us at:  
 SYSTEM STANDEX A/S  
 Høje Taastrupvej 107, DK-2620 Ballerup  
 Tlf: +45 44 44 44 44  
 E-mail: info@system-standex.dk  
 www.system-standex.dk

**SYSTEM STANDEX**

**De helt rigtige rammer til enhver virksomhed**  
- smarte, praktiske og fleksible på samme tid

- STOFPRINT
- STOFPRINT MED LEDLYS
- STOFPRINT MED AKUSTIKPLADE

**SYSTEM STANDEX**

**System Standex A/S**

Herluf Trolles Vej 140 · DK - 5220 Odense SØ  
Phone: +45 66 15 66 15 · Fax: +45 66 15 55 48  
info@system-standex.dk · system-standex.dk



**SYSTEM  
STANDEX®**