

STANDEX SKILTESYSTEMER



SNAPRAMMER
– med eller uden LED



RAMMER TIL STOFPRINT
– med eller uden LED

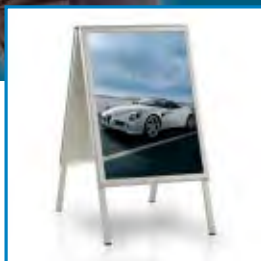

**SYSTEM
STANDEX®**

Snapramme 25mm

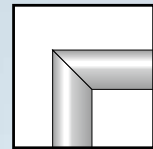
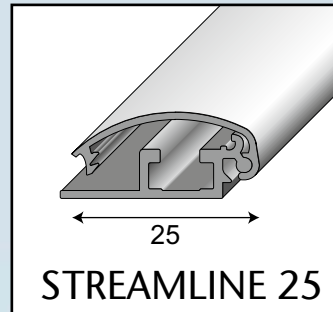

Standard:

Smig

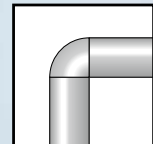

Alternativ:

Rund

Standard overflade:



Sølvanodiseret

Alternative muligheder:



Sortanodiseret



Pulverlakering i RAL-farver

Plakatmål:

- DIN A4 (210 x 297mm)
 - DIN A3 (297 x 420mm)
 - DIN A2 (420 x 594mm)
 - DIN A1 (594 x 841mm)
 - 500 x 700mm
 - 700 x 1000mm
- Alle størrelser kan naturligvis leveres

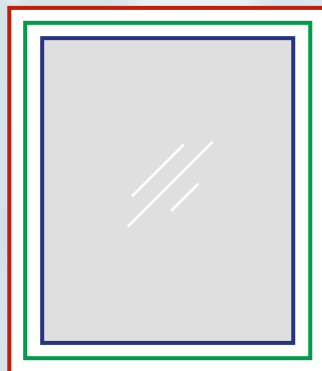

Rammemål = plakatmål plus 30mm
 Lysmål = plakatmål minus 20mm

Snaprammen har en 25mm buet aluminium profil og leveres med tilhørende refleksfri frontplade samt polystyren bagplade. Snapfunktionen gør det hurtigt og nemt at skifte budskabet i rammen, uden brug af værktøj. Alle fire sider åbnes og rammen er klar til brug. Snaprammen har 4 stk. huller forboret i underprofil for nemmere montering på væg. Er velegnet både til uden- og indendørs brug.

Andre formater og farver kan også leveres.

Kontakt vor salgsafdeling for mere information.



Snapramme 32mm

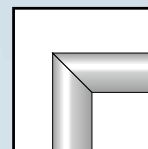
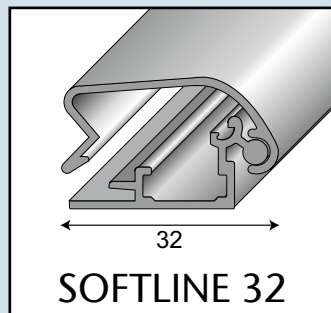

Standard:

Smig

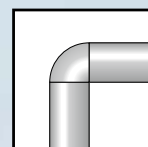

Alternativ:

Rund

Standard overflade:



Sølvanodiseret

Alternative muligheder:



Sortanodiseret



Pulverlakering i RAL-farver

Plakatmål:

- DIN A4 (210 x 297mm)
 - DIN A3 (297 x 420mm)
 - DIN A2 (420 x 594mm)
 - DIN A1 (594 x 841mm)
 - 500 x 700mm
 - 700 x 1000mm
- Alle størrelser kan naturligvis leveres

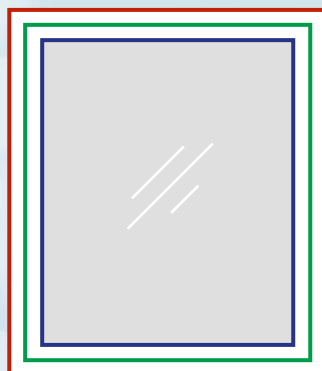

Rammemål = plakatmål plus 44mm
Lysmål = plakatmål minus 20mm

Snaprammen har en 32mm kantet aluminium profil og leveres med tilhørende refleksfri frontplade samt polystyren bagplade. Snapfunktionen gør det hurtigt og nemt at skifte budskabet i rammen, uden brug af værktøj. Alle fire sider åbnes og rammen er klar til brug. Snaprammen har 4 stk. huller forboret i underprofil for nemmere montering på væg. Er velegnet både til uden- og indendørs brug.

Andre formater og farver kan også leveres.

Kontakt vor salgsafdeling for mere information.



Snapramme 44mm

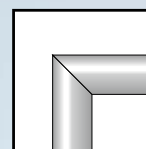
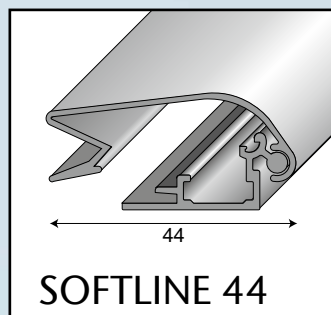

Standard:

Smig

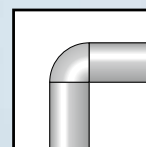

Alternativ:

Rund

Standard overflade:



Sølvanodiseret

Alternative muligheder:



Sortanodiseret



Pulverlakering i RAL-farver

Plakatmål:

- DIN A1 (594 x 841 mm)
- 500 x 700 mm
- 700 x 1000 mm
- 1000 x 1400 mm

– Alle størrelser kan naturligvis leveres

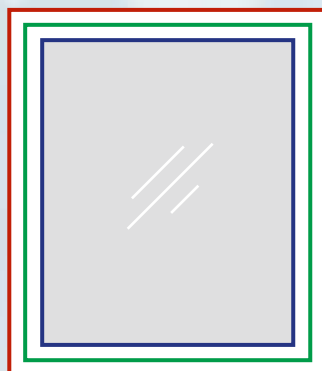

Rammemål = plakatmål plus 44mm
Lysmål = plakatmål minus 44mm

Snaprammen har en 44mm kantet aluminium profil og leveres med tilhørende refleksfri frontplade samt polystyren bagplade. Snapfunktionen gør det hurtigt og nemt at skifte budskabet i rammen, uden brug af værktøj. Alle fire sider åbnes og rammen er klar til brug. Snaprammen har 4 stk. huller forboret i underprofil for nemmere montering på væg. Er velegnet både til uden- og indendørs brug.

Andre formater og farver kan også leveres.

Kontakt vor salgsafdeling for mere information.



Snapramme til montering på vinduer

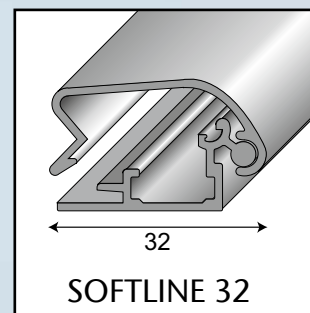
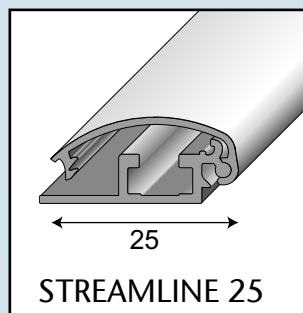
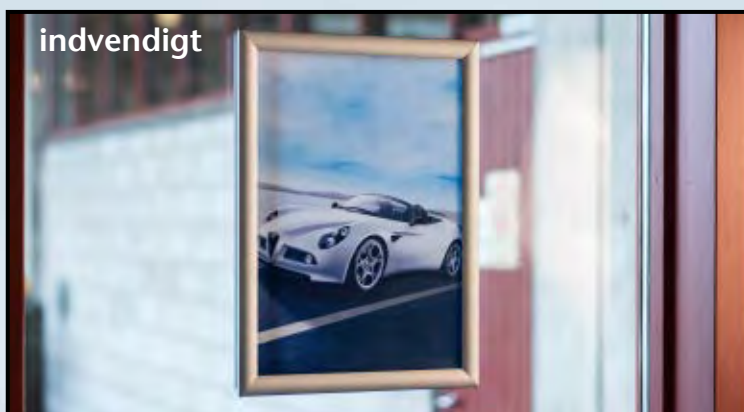
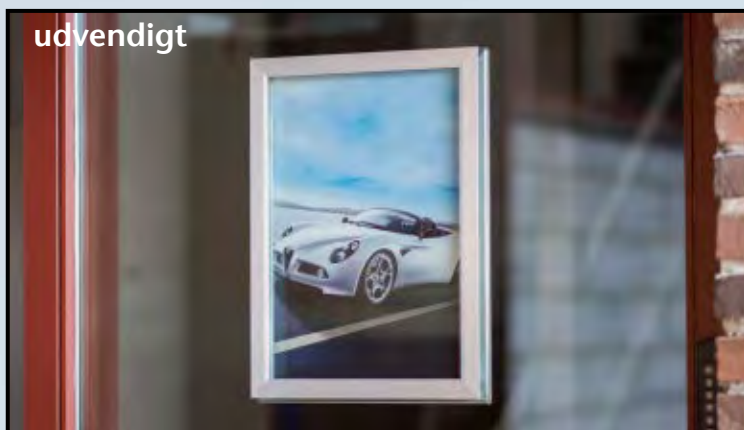

Standard overflade:



Sølvanodiseret

Alternative muligheder:



Sortanodiseret



Pulverlakering i RAL-farver

Plakatmål:

- DIN A4 (210 x 297mm)
 - DIN A3 (297 x 420mm)
 - DIN A2 (420 x 594mm)
 - DIN A1 (594 x 841mm)
 - 500 x 700mm
 - 700 x 1000mm
- Alle størrelser kan naturligvis leveres

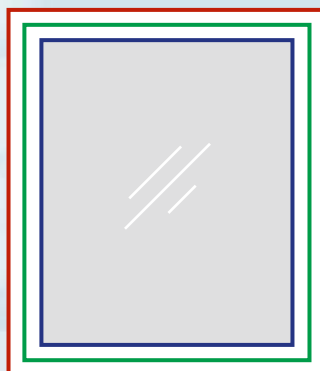

25mm streamline:

Rammemål = plakatmål plus 30mm
Lysmål = plakatmål minus 20mm

32mm softline:

Rammemål = plakatmål plus 44mm
Lysmål = plakatmål minus 20mm

Vinduessnaprammen kan laves i 25 eller 32mm aluminium profil og leveres med tilhørende refleksfri frontplade samt gennemsigtig akryl bagplade. Rammen leveres med dobbeltklæbende tape for montage. Pynterammen, som monteres udendørs, er ligeledes monteret med tape. Snapfunktionen gør det hurtigt og nemt at skifte budskabet i rammen, uden brug af værktøj. Alle fire sider åbnes og rammen er klar til brug. Rammen er monteret på indersiden af vinduet, hvilket giver let adgang til plakaten.

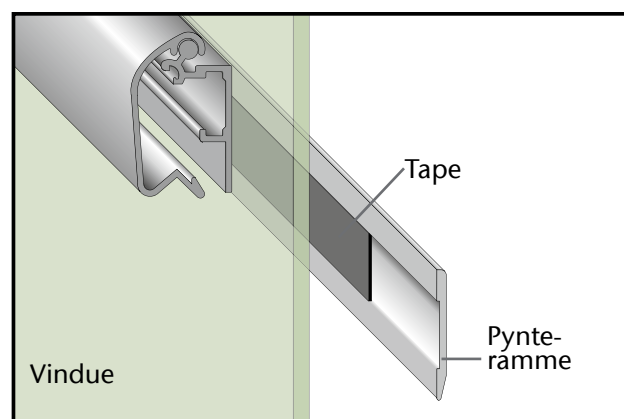

Sikkerhedsramme

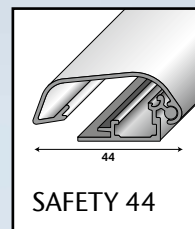
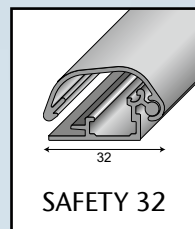

Standard overflade:



Sølvanodiseret

Alternative muligheder:



Sortanodiseret



Pulverlakering
i RAL-farver

Rammeåbner:



19mm



32mm



44mm

Plakatmål:

- DIN A4 (210 x 297mm)
 - DIN A3 (297 x 420mm)
 - DIN A2 (420 x 594mm)
 - DIN A1 (594 x 841mm)
 - 500 x 700mm
 - 700 x 1000mm
- Alle størrelser kan naturligvis leveres

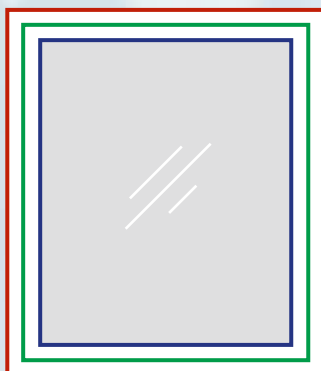

19mm safety:

Rammemål = plakatmål plus 30mm
Lysmål = plakatmål minus 8mm

32mm safety:

Rammemål = plakatmål plus 44mm
Lysmål = plakatmål minus 20mm

44mm safety:

Rammemål = plakatmål plus 44mm
Lysmål = plakatmål minus 44mm

Sikkerhedsrammen leveres i 19,32 og 44mm aluminium profil og leveres med tilhørende refleksfri frontplade samt polystyren bagplade. Snapfunktionen er med ekstra bladfydedre, og er ikke mulig at åbne uden brug af rammeåbner. Alle fire sider åbnes og rammen er klar til brug.

Sikkerhedsprofilen giver en bedre sikkerhed mod tyveri. Sikkerhedsrammen har 4 stk. huller forboret i underprofil for nem montering på væg.

Er velegnet til uden- og indendørs brug.

Andre formater og farver kan også leveres.

Kontakt vor salgsafdeling for mere information.



Indstiksramme 20mm

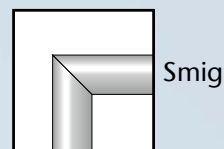
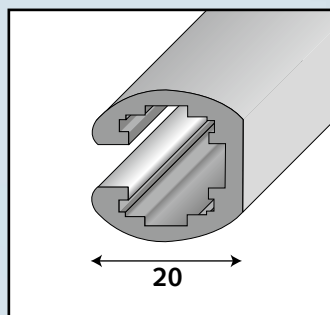

Standard overflade:



Sølvanodiseret

Alternativ overflade:



Pulverlakering i RAL-farver

Medietykkelse:

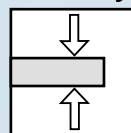

Max 3mm

Plakatmål:

- DIN A4 (210 x 297mm)
 - DIN A3 (297 x 420mm)
 - DIN A2 (420 x 594mm)
 - DIN A1 (594 x 841mm)
 - 500 x 700mm
 - 700 x 1000mm
- Alle størrelser kan naturligvis leveres

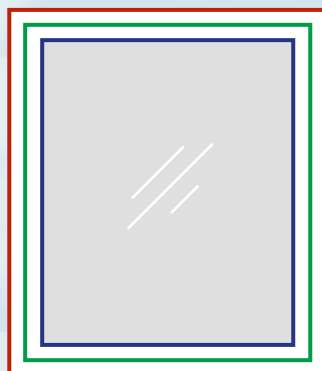

Rammemål = plakatmål plus 8mm
Lysmål = plakatmål minus 32mm

Indstiksrammen har en 20mm buet profil og leveres med tilhørende refleksfri frontplader. Plakaten kan indsættes fra siden eller toppen. En uigennemsigtig separationsplade af slagfast plast er placeret mellem de to plakater. Rammen kan ses fra begge sider og er beregnet til at hænge fra loftet.

Andre formater og farver kan også leveres.

Kontakt vor salgsafdeling for mere information.



Bannerprofiler



Profiler i standard mål:

- 210mm til A4
 - 297mm til A3
 - 420mm til A2
 - 594mm til A1
- Leveres i sæt med top og bund.
- Hele længder (3m til egen afkortning)

Bannerprofiler i varierende længder er ideelle til ophængning af plakater og bannere, og kan desuden monteres på væg. Profilerne leveres som standard med ophængsøjjer. Plakaterne skal blot klikkes ind i top- og bundprofil. Kontakt vor salgsafdeling for mere information.

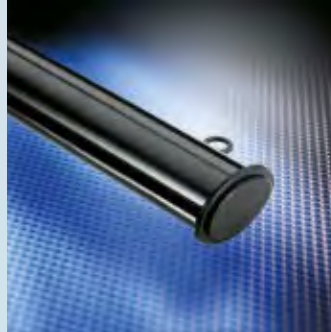

Klemfix Pro Double
plast

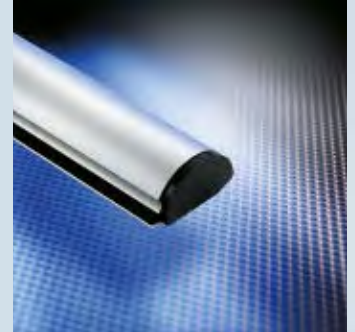

Bannerprofil 32mm
rund

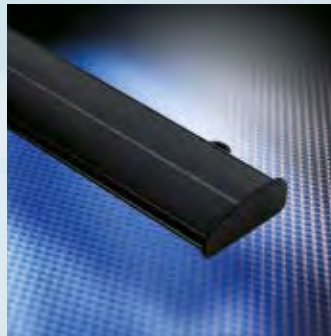

Klemfix 36mm plast

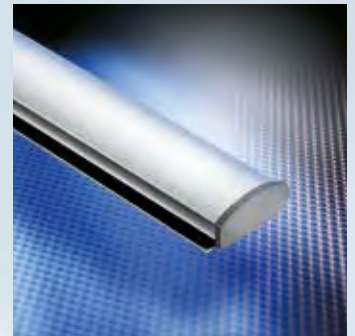

Bannerprofil 32mm
oval

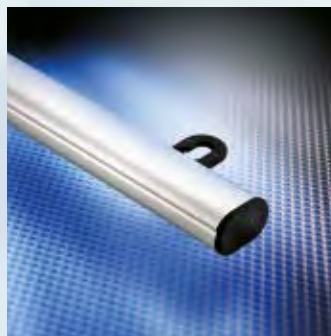

Klemfix alu 15x25mm
oval

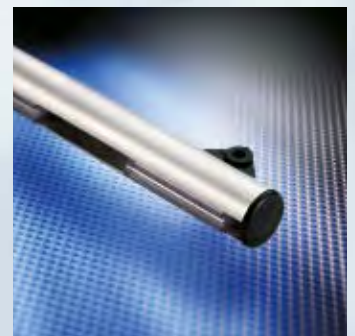

Posterprofil Ø19mm
rund



Klemfix 18mm plast

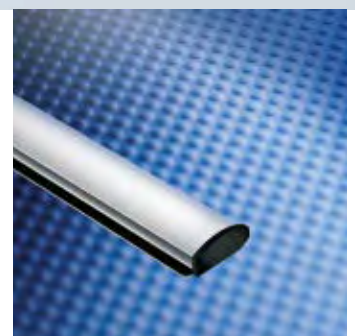

Bannerprofil 25mm
oval

Reservedele til snaprammer

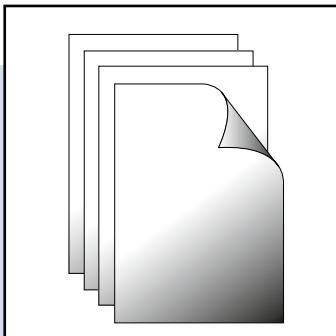

Refleksfri frontplader (5 stk/sæt)

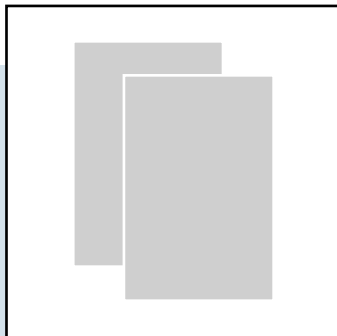

Bagplader for rammer, sæt á 2 stk.

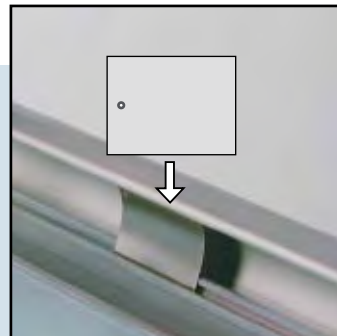

Bladfjedre til snaprammer i alle størrelser

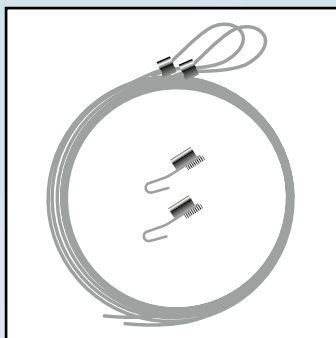

Stålwiresæt for ophængning af rammer 2x1,5m inkl. ophængskroge

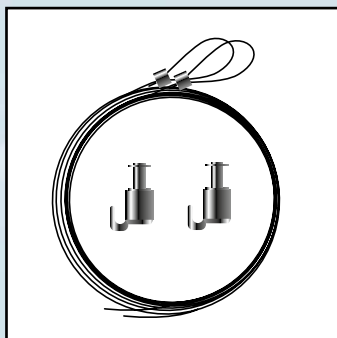

Stålwiresæt inkl. fixmatic kroge for ophængning af tunge rammer og lyskilte

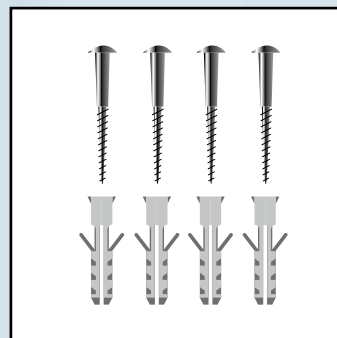

Sæt med skruer og rawlplug

Topskiltprofiler



21.621-PT



21.601-PT

Profiler i standard mål:

- 210mm til A4
- 297mm til A3
- til 3mm plader
- Leveres også på mål eller i længder á 6m

LED Snaprammer



LED rammer 25mm

Indendørs:

- DIN A4 (210 x 297mm)
- DIN A3 (297 x 420mm)
- DIN A2 (420 x 594mm)
- DIN A1 (594 x 841mm)
- 500 x 700mm
-enkelt eller dobbeltsidet
- 700 x 1000mm
-enkelt eller dobbeltsidet

– Alle størrelser kan naturligvis leveres

LED rammer 32mm

Udendørs og indendørs –enkeltsidet:

- DIN A4 (210 x 297mm)
- DIN A3 (297 x 420mm)
- DIN A2 (420 x 594mm)
- DIN A1 (594 x 841mm)
- 500 x 700mm
- 700 x 1000mm

– Alle størrelser kan naturligvis leveres

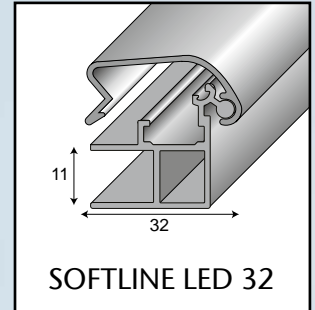
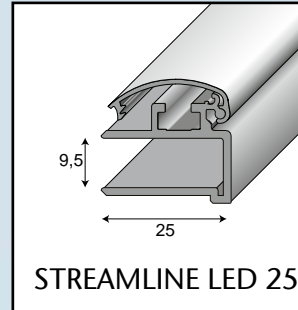

Standard overflade:

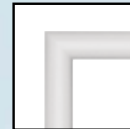

Sølvanodiseret

Alternative muligheder:



Pulverlakering
i RAL-farver

LED snaprammer gør dit budskab mere synligt. Med LED rammer får du lang levetid, lavt strømforbrug og ingen vedligeholdelse. Vi producerer LED rammer i alle størrelser med kort leveringstid.

De leveres både som uden- og indendørs.

Kontakt vor salgsafdeling for mere information.

Dobbelsidet



SmartFrames

–Rammer til stofprint



Profiler til enkeltsidet display:

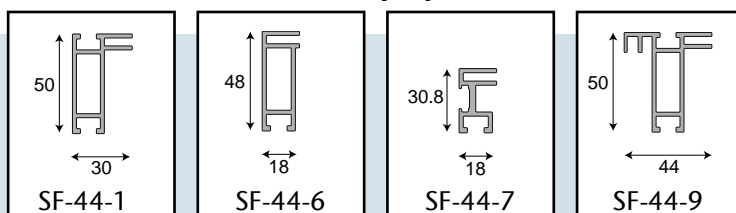

Profiler til dobbeltsidet display:

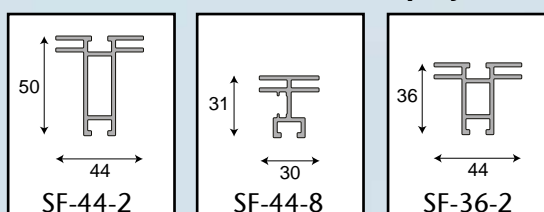

Standard overflade:



Sølv-anodiseret

Alternative muligheder:



Pulverlakering
i RAL-farver

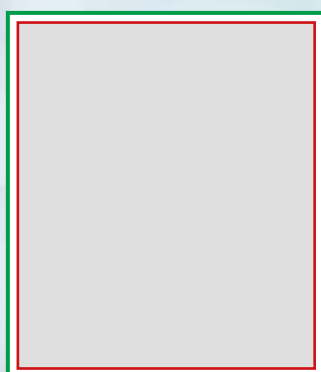

Smartframe:

Grafikmål = udvendigt mål
på ramme

Lysmål = udvendigt rammemål
minus 4mm

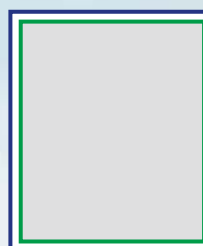

Grafikfil til print:

Bleed = grafikmål plus 40mm i
hver side

PDF i minimum 100 dpi i 1:1

Farver i CMYK

Skrifttyper vedlagt eller outlined

System Standex fremstiller rammer til stofprint i mål efter dit ønske, både enkeltsidet og dobbeltsidet. Til ophæng på væg, nedhængt fra loft eller fritstående. Kontakt os for uforpligtende tilbud.



Stofbanner med påsyet PVC-liste for hurtig og nem montering

LED SmartFrames

–lysrammer til stofprint

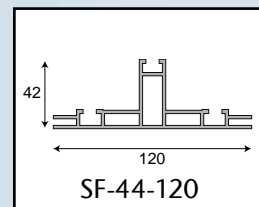
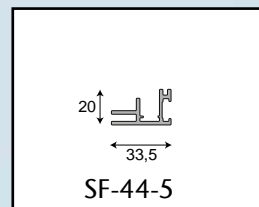
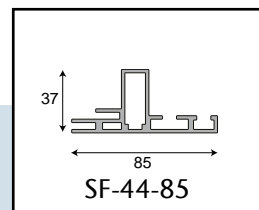
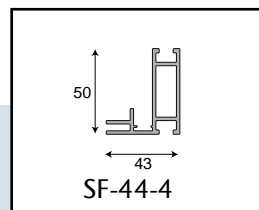

Standard overflade:



Sølvanodiseret

Alternative muligheder:



Pulverlakering
i RAL-farver

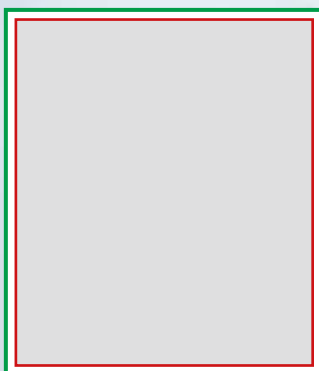

Smartframe:

Grafikmål = udvendigt mål
på ramme

Lysmål = udvendigt rammemål
minus 4mm

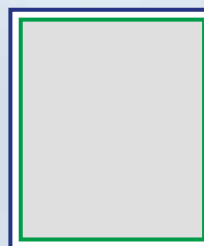

Grafikfil til print:

Bleed = grafikmål plus 40mm i
hver side

PDF i minimum 100 dpi i 1:1

Farver i CMYK

Skrifttyper vedlagt eller outlined

System Standex fremstiller lyskasser i mål efter dit ønske, både enkelt-sidede og dobbelt-sidede. Til ophæng på væg, nedhængt fra loft eller fritstående. Kontakt os for uforpligtende tilbud.



Stofbannet med påsyet PVC-liste for hurtig og nem montering

LED SmartFrames

–lysrammer til stofprint



System Standex tilbyder LED lysrammer:

- i størrelser efter ønske
- rammerne er enkelt eller dobbeltsidet
- vægophængt, nedhængt fra loft eller fritstående
- anvendes i butikker, på udstillinger, i showroom og mange andre steder

Vægmonteret i butik

Fritstående LED rammer



Fritstående i butik



Dobbeltsidet på udstilling



Fritstående i showroom

SELECT Udhængsskabe

① Rammeprofil:



Ydre mål 52mm
indre mål 25mm



Ydre mål 100mm
indre mål 73mm

② Montering:



Væghængt



Fritstående skab

③ Dør:



Højrehængt



Venstrehængt

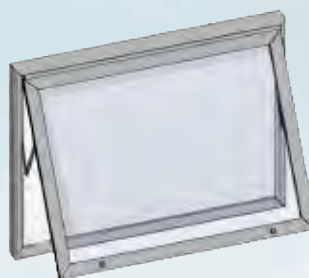

Tophængt

④ Ekstra muligheder:



Med indbygget lys

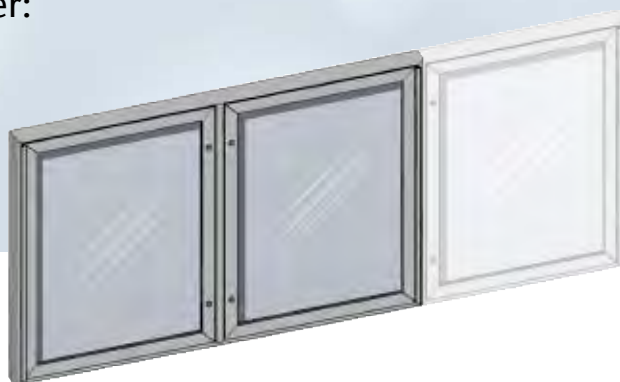

Flere vinduer i samme skab



Fritstående dobbelt skab

Udhængsskab eksempel størrelser

1 DØR:



1 x A4 (Portrait)
Udvendigt mål:
370 x 460 mm
Lysmål:
259 x 351 mm



6 x A4 (Landskab)
Udvendigt mål:
760 x 815 mm
Visual area/
Lysmål/Sichtbares Format:
649 x 706 mm



8 x A4 (Portrait) or A1 - tophængt
Udvendigt mål:
1000 x 755 mm
Lysmål:
891 x 644 mm



6 x A4 (Portrait)
Udvendigt mål:
815 x 760 mm
Lysmål:
704 x 651 mm



2 x A4 (Portrait)
Udvendigt mål:
370 x 760 mm
Lysmål:
259 x 651 mm



9 x A4 (Portrait)
Udvendigt mål:
815 x 1085 mm
Lysmål:
704 x 976 mm



16 x A4 (Portrait) or A0
Udvendigt mål:
1000 x 1405 mm
Lysmål:
889 x 1296 mm



12 x A4 (Portrait)
Udvendigt mål:
815 x 1405 mm
Lysmål:
704 x 1296 mm



2 x A4 (Portrait) or A3
Udvendigt mål:
580 x 460 mm
Lysmål:
469 x 351 mm



4 x A4 (Portrait) or A2
Udvendigt mål:
580 x 760 mm
Lysmål:
469 x 651 mm



8 x A4 (Landscape) or A1
Udvendigt mål:
760 x 1000 mm
Lysmål:
649 x 891 mm

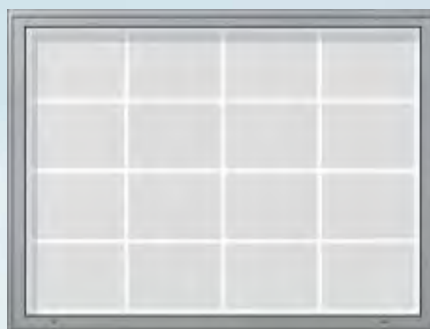

16 x A4 (Landscape) or A0 - tophængt
Udvendigt mål:
1405 x 1000 mm
Lysmål:
1296 x 884 mm



12 x A4 (Portrait)
Udvendigt mål:
1000 x 1085 mm
Lysmål:
889 x 976 mm

2 DØRE:



8 x A4 (Portrait) or A1
Udvendigt mål:
1148 x 760 mm
Lysmål:
2 x 469 x 651 mm



12 x A4 (Landscape)
Udvendigt mål:
1508 x 815 mm
Lysmål:
2 x 649 x 706 mm

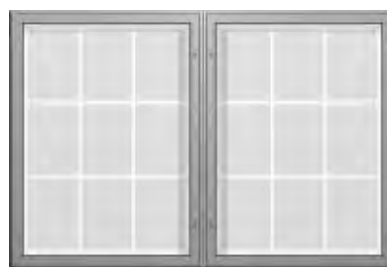

18 x A4 (Portrait)
Udvendigt mål:
1618 x 1085 mm
Lysmål:
2 x 704 x 976 mm

Specialmål kan
også leveres

Udhængsskab eksempler



System Standex leverer udhængsskabe til vægophæng eller med søjler til fritstående montering.



Skabene fås i eloxeret aluminium eller lakering efter ønske.



Der kan monteres indvendig LED belysning fra fabrikken.



Fritstående skabe kan leveres dobbeltsidet.

A-skilte & gadeskilte



Allround 2 stål



Allround 3 stål



Allround 4 stål

Allround 2,3 &4

- 500 x 700mm
- DIN A1 (594 x 841mm)
- 700 x 1000mm
- Udført i Ø25mm galvaniseret hvidlakeret stålør.
- Frontplade med magnet kant.
- Hjul med bremse kan monteres.



BetonMaster

- 700 x 1000mm
- 1000 x 1400mm
- Galvaniseret stel og betonfod.
- Vejer fra 120kg.
- Monteret med 2 stk. sikkerhedssnaprammer.



BetonMaster til palleløfter

- 700 x 1000mm
- 1000 x 1400mm
- Galvaniseret stel og betonfod.
- Vejer fra 120kg.
- Monteret med 2 stk. sikkerhedssnaprammer.
- Velegnet til palleløfter.



VekaLux

- 500 x 700mm
- DIN A1 (594 x 841mm)
- 700 x 1000mm
- Anodiseret aluminium-stander.
- Monteret med 2 stk. 32mm snaprammer.



Streamline

- DIN A1 (594 x 841mm)
- 700 x 1000mm
- Anodiseret aluminium-stander.
- Logo skilt.
- Monteret med 2 stk. 32mm snaprammer.



StormMaster

- 500 x 700mm
- DIN A1 (594 x 841mm)
- 700 x 1000mm
- Udført i galvaniseret understel.
- 2 stærke fjedre som giver god stabilitet.
- Monteret med 2 stk. snaprammer.



WindMaster

- 500 x 700mm
- DIN A1 (594 x 841mm)
- 700 x 1000mm
- Plastfod med 2 stærke fjedre.
- Foden er med 2 hjul i siden og kan fyldes med vand eller sand.
- Meget nem at flytte rundt på.
- Monteret med 2 stk. snaprammer

Eksempler på displaystandere



ODS 50
25mm A3 snaprammer
(dobbeltsidet)



ODS 70
A4 hylder og banner



ODS 2
Enkeltsidet 25mm LED
snapramme 500x1300mm

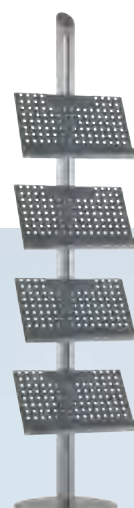

ODS 30
4x A3 hylder



ODS 32
A4 hylder



ODS 11
1 banner
-enkelt eller dobbeltsidet



ODS 73
25mm A4 snapramme og
hylder



ODS 74
Brochurehylde A3 og
32mm snapramme 600x1200mm



ODS 51
25mm A2 & A3 snaprammer



ODS 58
25mm A2 snaprammer

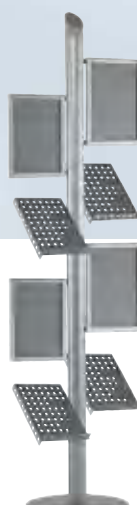

ODS 76
A4 hylder og 25mm
A4 snaprammer

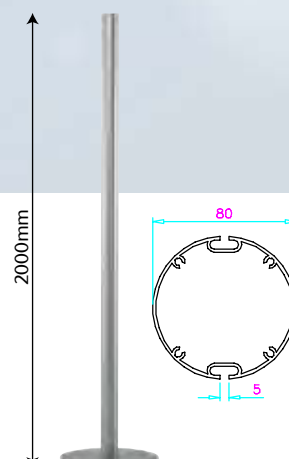

ODS
2000mm - ingen top
Ø450mm fodplade

Andre kombinationer og farver kan leveres. Kontakt vor salgsafdeling for mere information.

Brochurestander



1217-1-A -foldbar
5 hylde A4



KVADRAT -stationær
3 hylde A4



1217-1800 -stationær
4 hylde A4 + 1 stoframme (dobbelt-sided)

Infostander



Inforstander A4
portræt



Infostander A3
landskab



Infostander LED A3
landskab



iPad Display Stand
(fås også til andre tablets)

Demodisk -foldbare

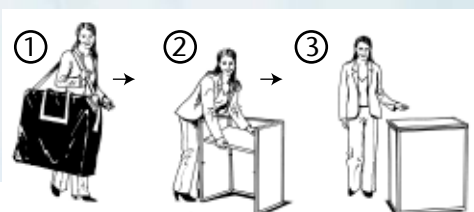

PC-1



PC-2



PC-1-LED



PC-2-LED

System Standex demodiske kan leveres med tasker, plader, skydelåger og meget andet tilbehør.
Kontakt vor salgsafdeling for mere info.

■ Hos System Standex er vi specialister i udvikling og produktion af løsninger med alu-konstruktioner. Løsningerne er baseret på vores egne profiler og samlemetoder, som giver nærmest uendelige muligheder for individuel udformning. Vi har egen produktion, overfladebehandling og montagefabrik. Det sikrer dig den største fleksibilitet i udformning og levering. Kontakt os om din opgave.

50 SYSTEM
STANDEX®
1964-2014

For information om:

Beslag, fittings og wire systemer til ophæng af skilte, plader og glas



**SYSTEM
STANDEX®**

Butiksudstilling
& display



Brochurestander
Acryl-lommer
Wire Display
Displaystander
LightPocket
Udhængsskab

**SYSTEM
STANDEX®**

Kontakt os nu på:

SYSTEM STANDEX A/S

Herluf Trolles Vej 140 - DK-5220 Odense SØ

Tel.: +45 66 15 66 15 Fax.: +45 66 15 55 48

info@system-standex.dk - www.system-standex.dk



**SYSTEM
STANDEX®**